

PAC ANNUAL CONFERENCE
PROFESSIONAL ACCOUNTING FUTURES

FTX Failure:
Lessons from An Investigator

Peter Easton

Notre Dame Alumni Professor of Accountancy
Academic Director, Center for Accounting Research and Education
Editor in Chief, Accountability in a Sustainable World Quarterly
University of Notre Dame



Professional Accounting Centre
UNIVERSITY OF TORONTO
MISSISSAUGA

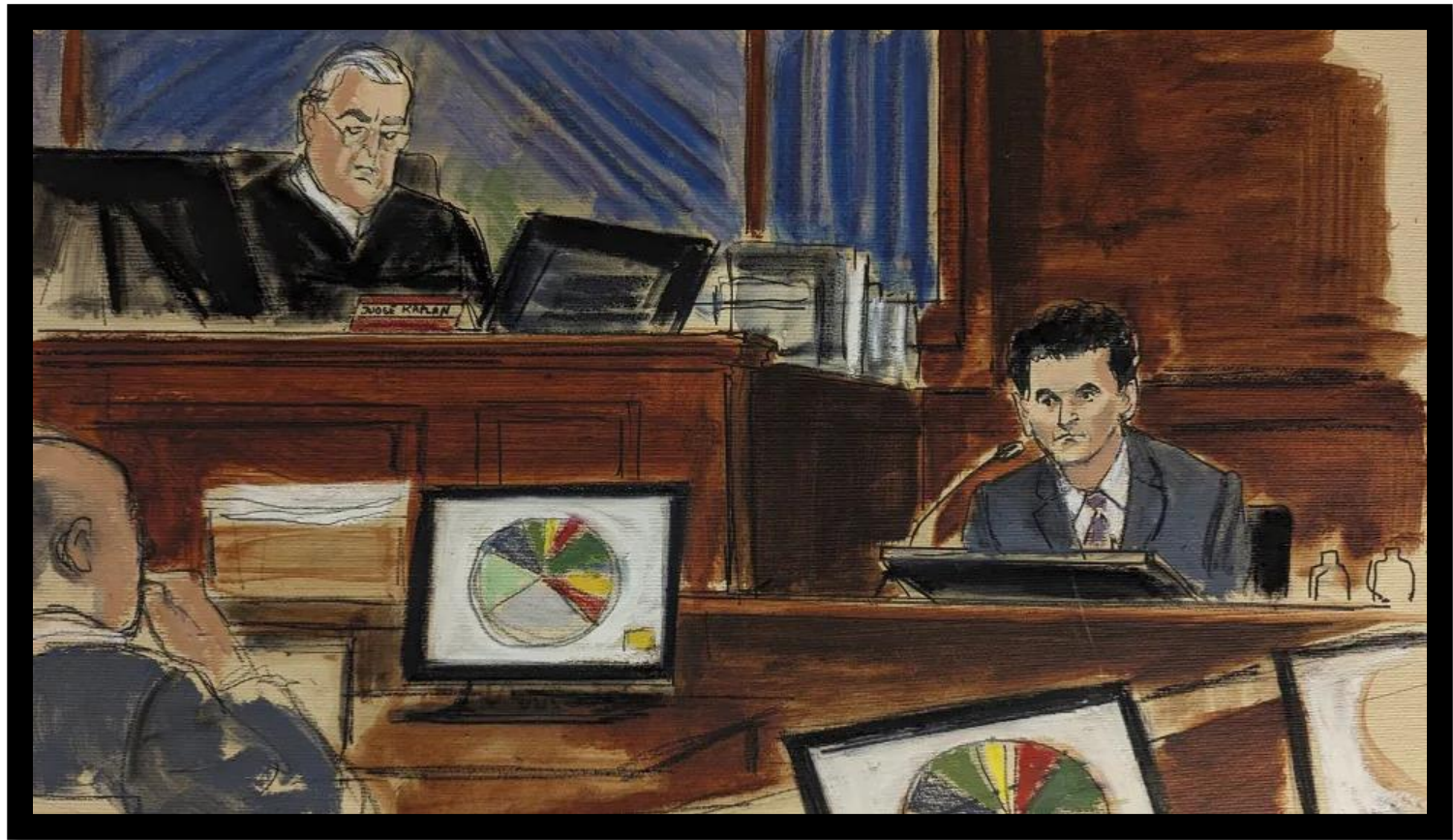

Materials Reviewed

Bank Statements and Wires



ALAMEDA RESEARCH LTD
 MARKET MAKER
 TORTOLA PIER PARK, BLDG. I SECOND FLOOR
 WICKHAM CAY I. ROAD TOWN TORTOLA
 BRITISH VIRGIN ISLAN

Page 54 of 54

Account Number: *****4456
 Date 09/30/21

Debits and Other Withdrawals

Date	Amount	Activity Description
9/29	1,418,125.75	L09TL07131313RT8G BENE:JST DIGITAL TRADING AND TECHNOLOG
9/29	20,000,000.00	Ref 2721628 to Dep 5090006056
9/30	1,999.00	L09UH1028522BCLD BENE:BRUNO MAIA ANTONIO LUIZ
9/30	21,100.00	L09UH1036JG22VOI BENE:LANIER AI LABS LLC
9/30	39,933.00	L09UH10329H2BCMR BENE:HZ TELECOM HONG KONG LIMITED
9/30	150,000.00	L09UH1022QF33GSM BENE:DOMINIC HEI-KIU TSANG
9/30	185,325.48	L09UH1033A52BCN4 BENE:YUECHEN JIAO
9/30	324,000.00	L09UL1219EZ35HC1 BENE:2750389 ONTARIO INC.
9/30	1,467,828.65	L09UH10259V33GTP BENE:JST DIGITAL TRADING TECHNOLOGY PT



NORTH DIMENSION INC.
 2000 CENTER ST STE 400
 BERKELEY CA 94704-1996

Page 43 of 703

Account Number: *****8738
 Date 10/29/21

Deposits and Other Credits

Date	Amount	Activity Description
10/05	51,107.44	L0A565347HN5BDPY ORIG:WU CHING CHING
10/05	52,000.00	L0A5G5640PG4M02N ORIG:MOHAMED MOAWAD ZAHRA, 12 MABOOTHE
10/05	54,208.24	L0A572112GL4BTQK ORIG:HAI GUI CO., LTD.
10/05	59,970.00	L0A5E0302CB59XVT ORIG:FAHD ABDULAZIZ IBRAHIM ALSMAIL
10/05	66,000.00	L0A5H1340NS58L6D ORIG:YU-CHIH CHEN +
10/05	70,000.00	L0A5727397B4Q6KK ORIG:LIN CHAO CHUNG
10/05	71,200.00	L0A572529PRS2GZX ORIG:CHIEN CHAO CHANG
10/05	78,834.34	L0A5735000R4GES3 ORIG:HUANG, YEN JUNG

Sources: GX-1336,GX-1338

Materials Reviewed

FTX Database

- FTX
 - Connections
 - ftx.com - ftx-prod-govt-20230130-cluster.cluster-ro-cl9gkh
 - Databases
 - ftx
 - Schemas
 - public
 - Tables
 - account_kyc_files
 - account_kyc_forms
 - account_settings
 - account_value_snapshots
 - accounts
 - activity_records
 - admin_permissions
 - admin_proposed_transfers
 - admin_tasks
 - airdrops
 - api_activity
 - api_results
 - apple_account_info
 - argentinian_cbu_cvus
 - arksigner_kycs
 - aud_deposits
 - backstop_capacities
 - backstop_rules
 - badge_events
 - balance_changes
 - balance_snapshots
 - balances
 - bank_accounts
 - bank_balance_snapshots
 - bank_records
 - banks
 - bcoins_kyc_submissions
 - binary_option_balances
 - binary_option_fills
 - binary_option_trades
 - binary_options
 - block_trade_fills
 - block_trades
 - blockchain_tx_infos
 - blockfi_loans
 - blockfolio_interest_payments
 - blockfolio_interest_settings

until	account_id	balances	positions	options_positions	binary_options_positions	123_fee_voucher_balance	123_options_usd_balance	futures_pnl
2020-01-01 00:00:00.000	1,575,939	("1": "72.2724883808860000", "43": "0.00000190")	()	()	()		0	0
2020-01-01 00:00:00.000	1,566,725	("1": "0.6706874001104088")	()	()	()		0	("3": "-127.0517500000000")
2020-01-01 00:00:00.000	1,661,959	("1": "6.0322677950000000", "43": "0.00021000")	()	()	()		0	0
2020-01-01 00:00:00.000	1,883,656	("1": "7.5280400E-9")	()	()	()		0	0
2020-01-01 00:00:00.000	1,522,185	("1": "0.0004171353665000")	()	()	()		0	("3": "-138.6757750000000")
2020-01-01 00:00:00.000	1,473,548	("1": "1.32833109")	()	()	()		0	0
2020-01-01 00:00:00.000	1,594,894	("1": "-0.1904719300000000", "112": "12.920000")	()	()	()		0	0
2020-01-01 00:00:00.000	1,687,068	("1": "0.0520409340000000", "43": "0.00002525")	()	()	()		0	0
2020-01-01 00:00:00.000	1,673,247	("1": "0.1791270140000000", "112": "20.60000000")	()	()	()		0	("3": "113.67007500000000")
2020-01-01 00:00:00.000	1,280,547	("1": "0.0004763471564963", "21": "0.00344820")	()	()	()		0	0
2020-01-01 00:00:00.000	1,672,227	("1": "813.2420907326669913", "112": "187.1000")	()	()	()		0	("213": "24.79837500000000")
2020-01-01 00:00:00.000	1,697,319	("1": "-1.701749551250000", "43": "0.00040000")	()	()	()		0	0
2020-01-01 00:00:00.000	1,592,361	("43": "0.02000000")	()	()	()		0	0
2020-01-01 00:00:00.000	1,343,022	()	()	()	()		0	0
2020-01-01 00:00:00.000	1,899,058	("1": "2.7001312E-9", "44": "0.99676516")	()	()	()		0	0
2020-01-01 00:00:00.000	1,903,155	()	()	()	()		0	0
2020-01-01 00:00:00.000	1,584,694	("1": "3753.8788811693899380", "176": "2490.00")	()	()	()		0	0
2020-01-01 00:00:00.000	1,283,641	("1": "8.3137934353206618", "43": "8.1320000E-")	()	()	()		0	0
2020-01-01 00:00:00.000	1,299,009	("1": "1847.570719700000000", "95": "2000.000")	()	()	()		0	0
2020-01-01 00:00:00.000	1,572,420	("1": "711.6141415350000000", "121": "0.260000")	()	()	()		0	0
2020-01-01 00:00:00.000	1,889,861	("1": "0.000828862550000000")	()	()	()		0	0
2020-01-01 00:00:00.000	1,310,790	("44": "1.2500000000000000")	()	()	()		0	0
2020-01-01 00:00:00.000	1,467,462	("1": "0.551722553587000", "95": "202.00000000")	()	()	()		0	0
2020-01-01 00:00:00.000	1,452,621	("44": "0.00502100")	()	()	()		0	0
2020-01-01 00:00:00.000	1,560,146	("1": "0.8362499000000000", "74": "0.18000000")	()	()	()		0	0
2020-01-01 00:00:00.000	1,899,092	("1": "1.2000000E-9")	()	()	()		0	0
2020-01-01 00:00:00.000	1,714,778	("1": "0.2921999336987718", "202": "0.00800000")	()	()	()		0	0
2020-01-01 00:00:00.000	1,657,947	("1": "0.0021823716250000", "19": "0.72255110")	()	()	()		0	0
2020-01-01 00:00:00.000	1,439,327	("1": "26479.2277698511472100")	("24": "-1000.000000000")	()	()		0	0
2020-01-01 00:00:00.000	1,899,109	("1": "9.2876689E-9", "44": "0.78461330")	()	()	()		0	0
2020-01-01 00:00:00.000	1,566,827	("1": "-1.5902875378514578", "43": "3.8625E-12")	()	()	()		0	0
2020-01-01 00:00:00.000	1,883,758	()	()	()	()		0	0
2020-01-01 00:00:00.000	1,465,456	("1": "0.0000010752351845")	()	()	()		0	0
2020-01-01 00:00:00.000	1,582,195	("1": "25893.1993033067650000", "43": "0.00257")	()	()	()		0	0
2020-01-01 00:00:00.000	1,529,461	("1": "0.05152678750000000", "19": "0.00697000")	()	()	()		0	0
2020-01-01 00:00:00.000	1,790,071	("1": "0.09043757")	()	()	()		0	0
2020-01-01 00:00:00.000	1,336,953	("1": "0.0000461004853583", "43": "8.6320000E-")	()	()	()		0	0
2020-01-01 00:00:00.000	1,657,981	("1": "468.1611765753610000", "112": "423.0000")	()	()	()		0	0
2020-01-01 00:00:00.000	1,635,966	("1": "0.446068493500000000")	()	()	()		0	0
2020-01-01 00:00:00.000	1,564,804	()	()	()	()		0	0



Materials Reviewed

Cryptocurrency Blockchain Records

Transaction hash

0x91f635dd885f2cb38a281
7383f19dc60b75813b879b9
6e60403186b8d6681155 

Initiator [0x962fe6f349c320417e19
92443c0852b1d95060f2](#) 

Contract  [0xb911c9ab63600b84b
17ef37720b332c73231e904](#) 

Transaction purpose

Contract interaction

[All events](#) 1

Internal value ?

4,399.90 ETH · 6,425,958 USD

Transaction fee ?

0.00113183645673486 ETH ·
1.65 USD

11 months ago ·

Oct 26, 2022 10:38 PM UTC

Materials Reviewed

Records from FTX and Third-Party Lenders

Genesis

Genesis Global Capital, LLC

111 Town Square Place, Suite 1203 Jersey City, NJ 07310

genesis trading.com

Date: 08/31/2022

Alameda Research - Invoice Summary August 2022 (as of: 08/31/2022)

Alameda Research Ltd

Tortola Pier Park, Building 1, Second Floor, Wickhams Cay I, Road Town, Tortola, VG1110

Accrued Interest

Currency	Accrued Interest	Accrued Interest (\$)
BNB	128.21917808	
BTC	33.36583864	
ETH	338.40493151	
LINK	2,158.10958904	
LTC	394.08219178	
MATIC	53,506.84931507	
USD		\$3,684,113.01
USDP	19,534.24657534	
ZEC	424.65753425	

Conclusions

1. The amount of customer deposits held in Alameda Research and FTX bank accounts was far less than what was owed to customers of FTX.
2. Alameda Research used customer fiat deposits to pay for expenditures.
3. The amount held in FTX hot and cold cryptocurrency wallets was far less than what was owed to customers of FTX.
4. Alameda Research used customer cryptocurrency funds to pay for expenditures.

Customer Fiat Deposit Deficit

FTX Fiat Liability Compared to Fiat Bank Balances

January 1, 2021 - November 11, 2022

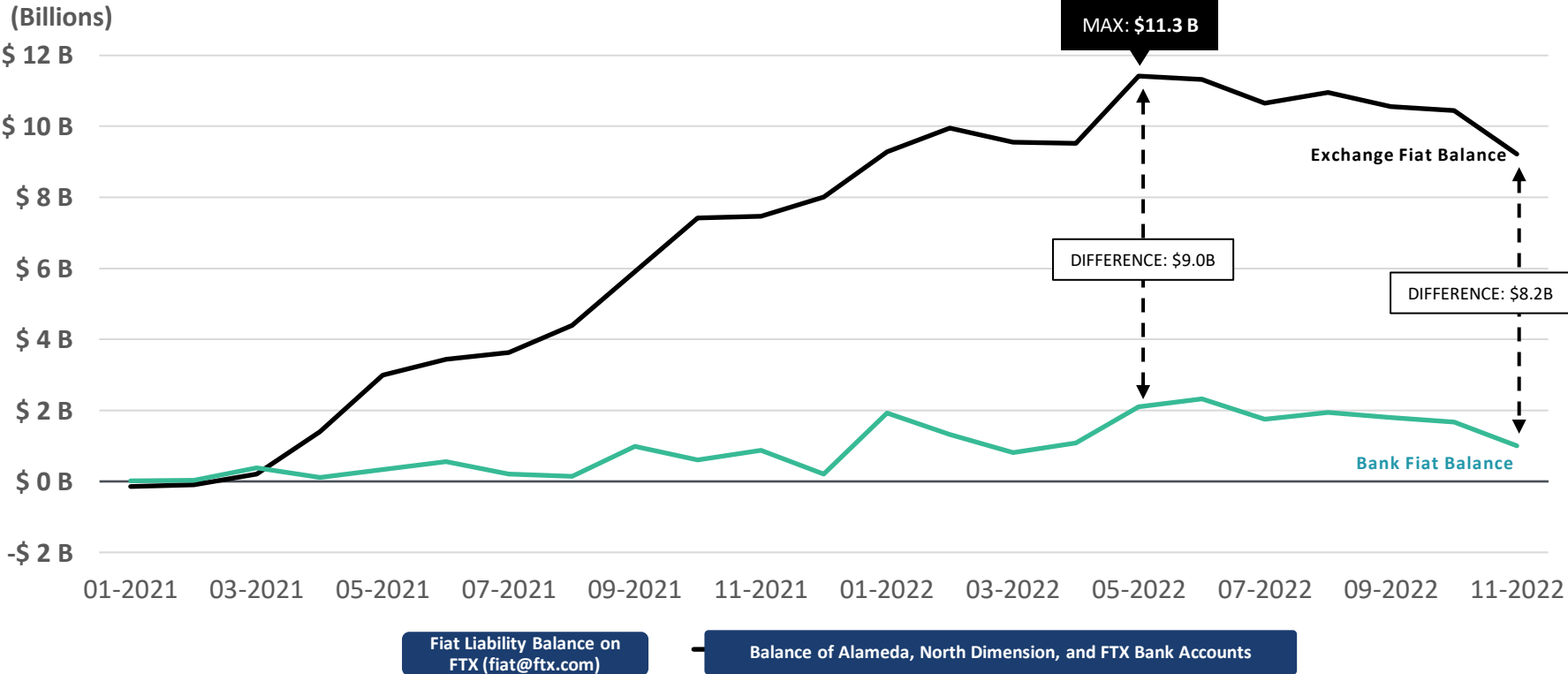

GOVERNMENT EXHIBIT 1004B
22 Cr. 673 (LAK)

Sources: GX-142, GX-143, GX-148, GX-150, GX-151, GX-152, GX-153, GX-154, GX-155, GX-156, GX-157, GX-158, GX-160, GX-161, GX-162, GX-163, GX-166, GX-167, GX-168, GX-172, GX-173, GX-345, GX-346, GX-1305, GX-1306, GX-1311, GX-1312, GX-1320, GX-1323, GX-1324, GX-1325, GX-1326, GC-1336, GX-1337, GX-1338, GX-1713, GX-1714, GX-2213-GX-2298, GX-2304-GX-2314, GX-2316, GX-2318-GX-2330

Spending Allocation for June 2022 \$11.3 Billion Liability

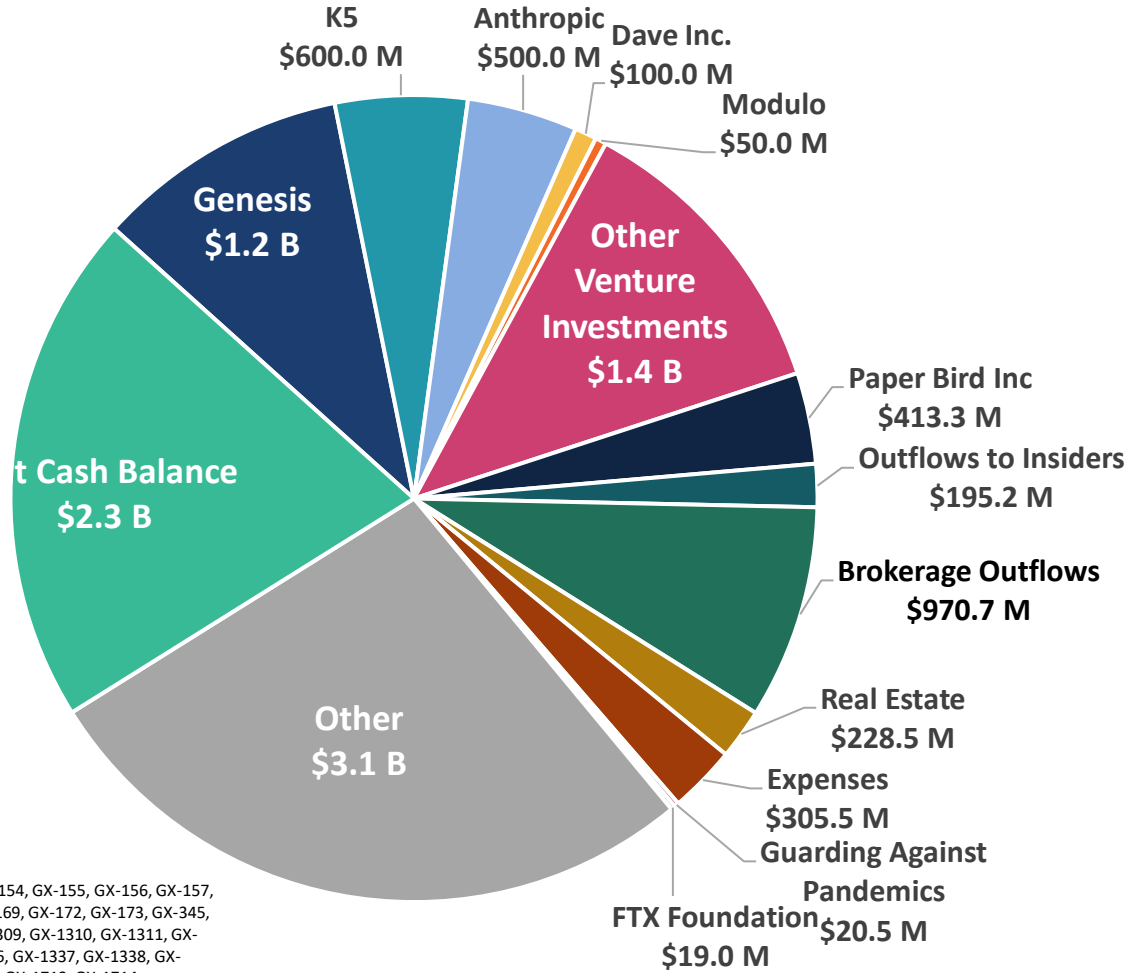

Sources: GX-142, GX-143, GX-148, GX-150, GX-151, GX-152, GX-153, GX-154, GX-155, GX-156, GX-157, GX-158, GX-160, GX-161, GX-162, GX-163, GX-166, GX-167, GX-168, GX-169, GX-172, GX-173, GX-345, GX-346, GX-1245, GX-1246, GX-1305, GX-1306, GX-1307, GX-1308, GX-1309, GX-1310, GX-1311, GX-1312, GX-1313, GX-1320, GX-1323, GX-1324, GX-1325, GX-1326, GC-1336, GX-1337, GX-1338, GX-1339, GX-2213-GX-2298, GX-2304-GX-2314, GX-2316, GX-2318-GX-2330, GX-1713, GX-1714

Use of Customer Fiat Deposits

Commingling of Customer Fiat Deposits With Other Funds

January 1, 2022 – November 11, 2022

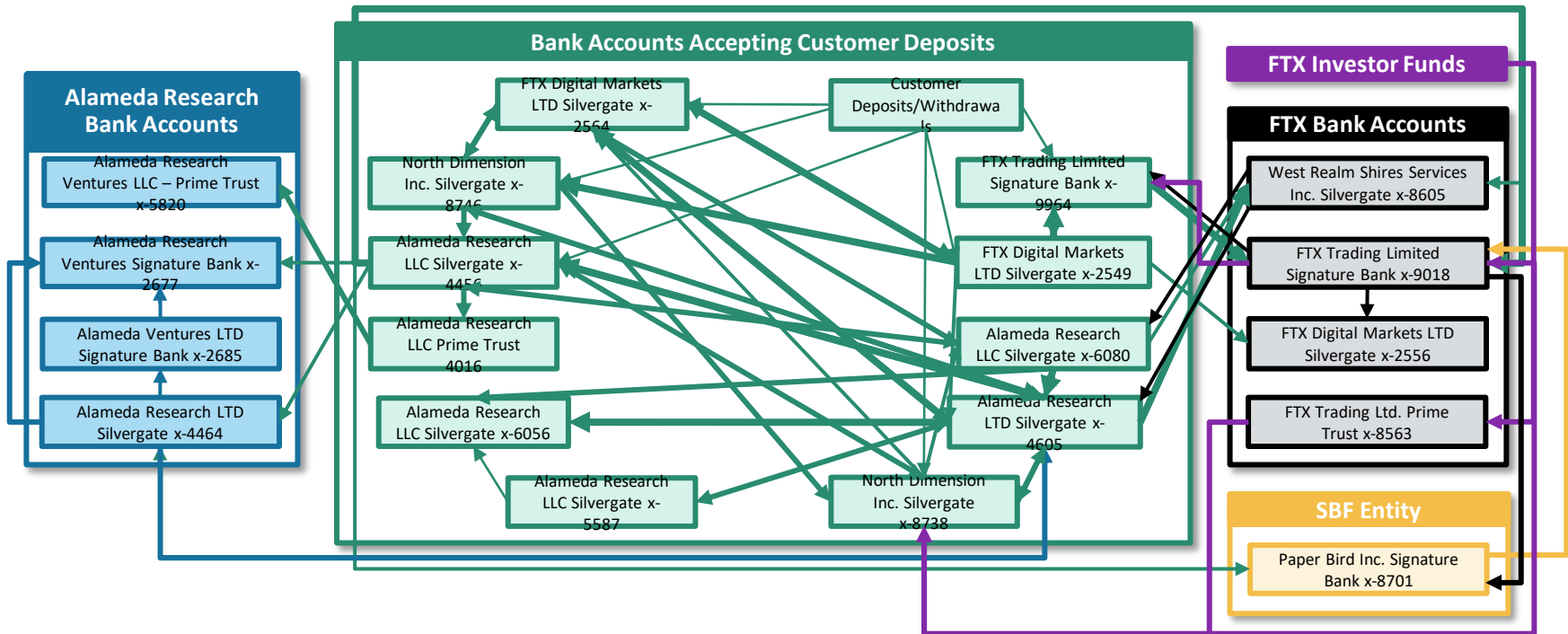

GOVERNMENT EXHIBIT 1050
22 Cr. 673 (LAK)

Sources: GX-1309, GX-1310, GX-1312, GX-1320, GX-1333, GX-1334, GX-1336, GX-1337, GX-1338, GX-1339
*This figure reflects a sub-set of bank accounts that accept customer deposits and that received customer deposits

Uses of Customer Funds

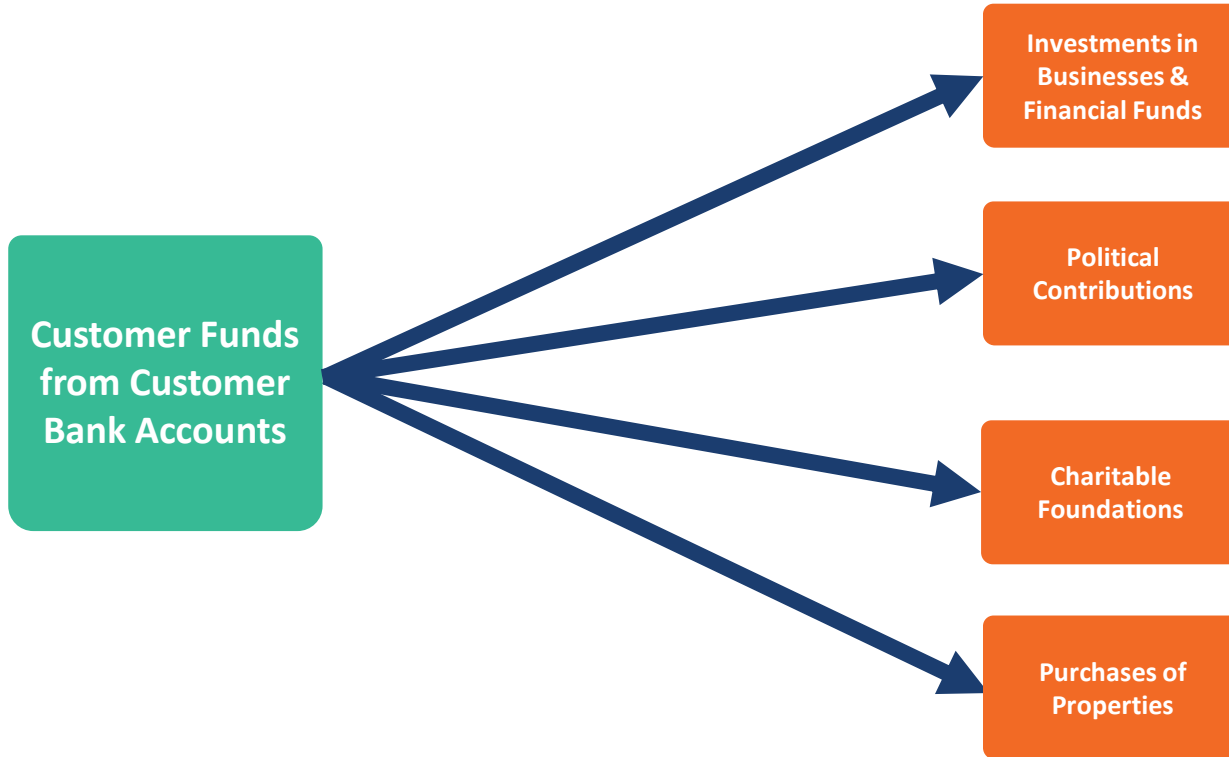

Use of Customer Funds to Pay for Transfer to Modulo Capital

June 27, 2022 – September 26, 2022

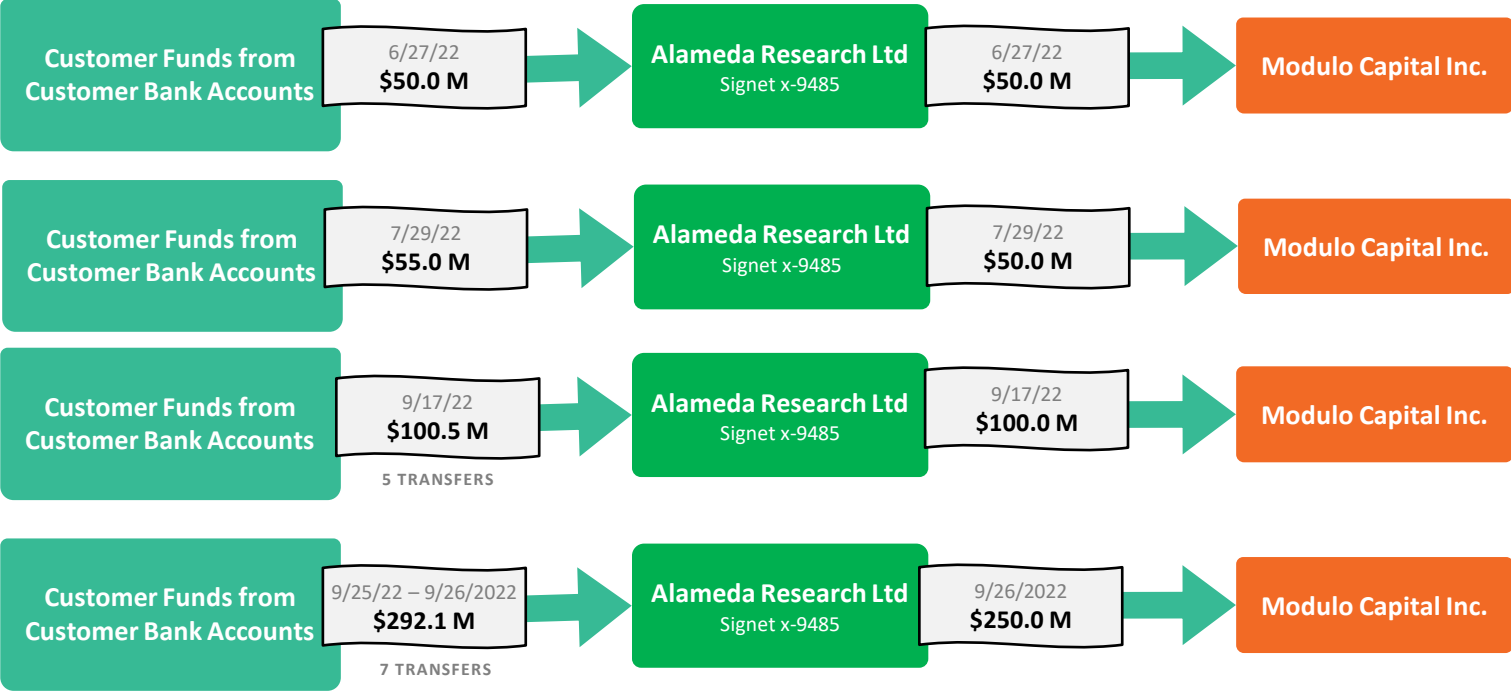

Sources: GX-1326

Use of Customer Funds to Pay for Transfer to Modulo Capital

June 27, 2022 – September 26, 2022

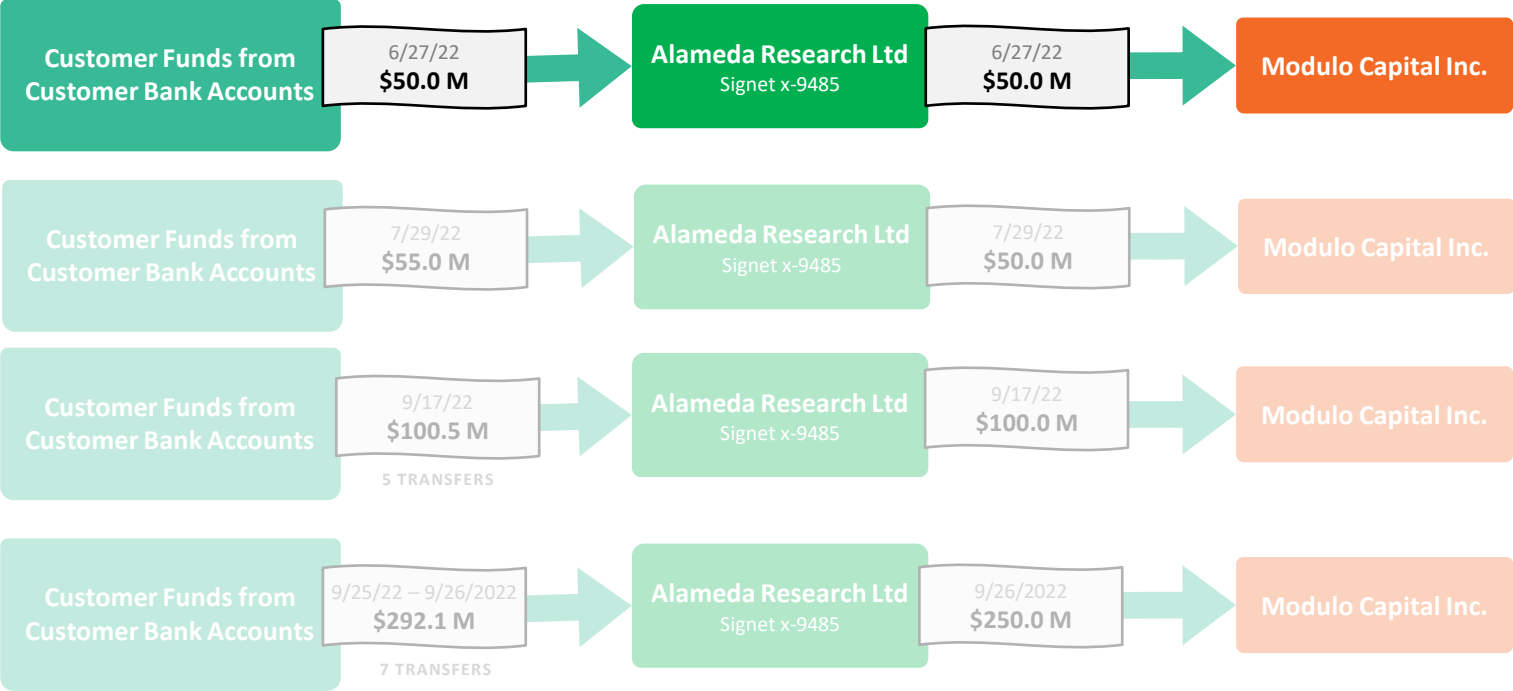

Sources: GX-1326

Use of Customer Funds to Pay for Transfer to Modulo Capital

June 27, 2022 – September 26, 2022

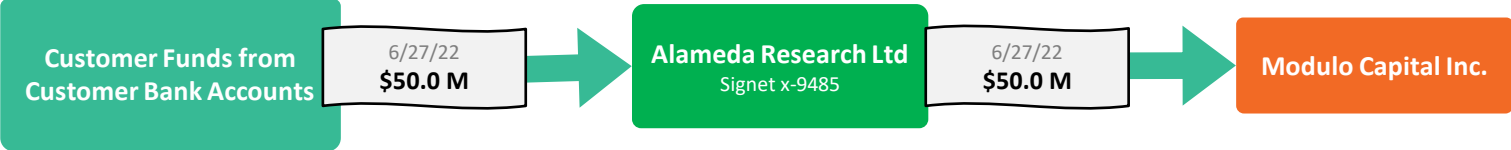

Account Name	Transaction Date/Time	Effective Date	Debit/Credit	Payee/Payor	Amount (+)	Amount (-)
Alameda Research Ltd Signet x-9485	Jun 27 2022 09:58:39	6/27/2022	Debit	MODULO CAPITAL INC		(\$1.00)
Alameda Research Ltd Signet x-9485	Jun 27 2022 10:08:39	6/27/2022	Credit	CIRCLE INTERNET FINANCIAL INC	\$50,000,000.00	
Alameda Research Ltd Signet x-9485	Jun 27 2022 10:09:10	6/27/2022	Debit	MODULO CAPITAL INC		(\$49,999,999.00)

Sources: GX-1326

Use of Customer Funds to Pay for Transfer to Modulo Capital

June 27, 2022 – September 26, 2022

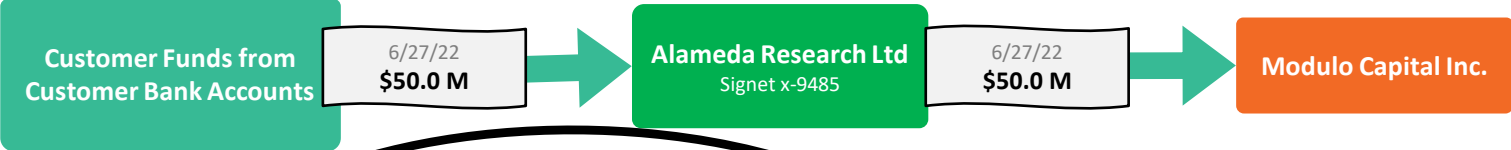

Account Name	Transaction Date/Time	Effective Date	Debit/Credit	Payee/Payor	Amount (+)	Amount (-)
Alameda Research Ltd Signet x-9485	Jun 27 2022 09:58:39	6/27/2022	Debit	MODULO CAPITAL INC		(\$1.00)
Alameda Research Ltd Signet x-9485	Jun 27 2022 10:08:39	6/27/2022	Credit	CIRCLE INTERNET FINANCIAL INC	\$50,000,000.00	
Alameda Research Ltd Signet x-9485	Jun 27 2022 10:09:10	6/27/2022	Debit	MODULO CAPITAL INC		(\$49,999,999.00)

Sources: GX-1326

Use of Customer Funds to Pay for Transfer to Modulo Capital

June 27, 2022 – September 26, 2022

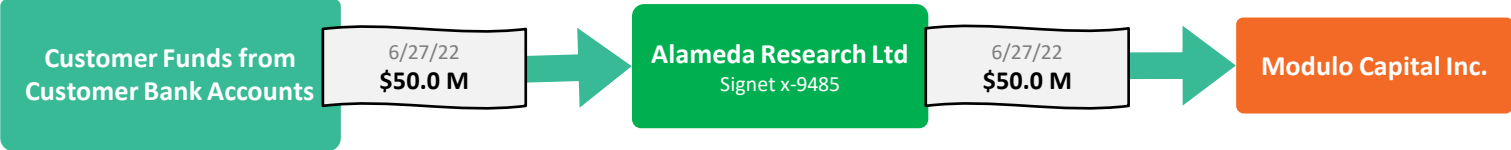

Account Name	Transaction Date/Time	Effective Date	Debit/Credit	Payee/Payor	Amount (+)	Amount (-)
Alameda Research Ltd Signet x-9485	Jun 27 2022 09:58:39	6/27/2022	Debit	MODULO CAPITAL INC		(\$1.00)
Alameda Research Ltd Signet x-9485	Jun 27 2022 10:08:39	6/27/2022	Credit	CIRCLE INTERNET FINANCIAL INC	\$50,000,000.00	
Alameda Research Ltd Signet x-9485	Jun 27 2022 10:09:10	6/27/2022	Debit	MODULO CAPITAL INC		(\$49,999,999.00)

Sources: GX-1326

Use of Customer Funds to Pay for Transfer to Modulo Capital

June 27, 2022 – September 26, 2022

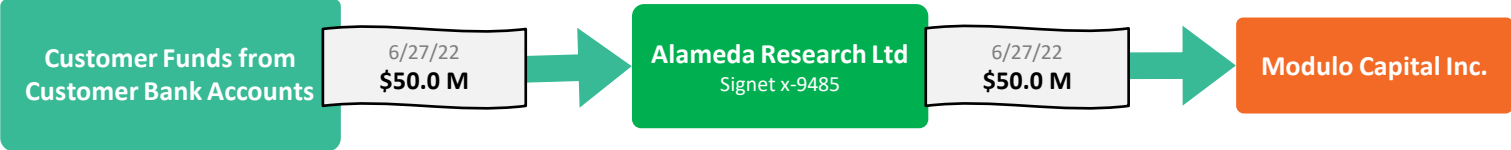

Account Name	Transaction Date/Time	Effective Date	Debit/Credit	Payee/Payor	Amount (+)	Amount (-)
Alameda Research Ltd Signet x-9485	Jun 27 2022 09:58:39	6/27/2022	Debit	MODULO CAPITAL INC		(\$1.00)
Alameda Research Ltd Signet x-9485	Jun 27 2022 10:08:39	6/27/2022	Credit	CIRCLE INTERNET FINANCIAL INC	\$50,000,000.00	
Alameda Research Ltd Signet x-9485	Jun 27 2022 10:09:10	6/27/2022	Debit	MODULO CAPITAL INC		(\$49,999,999.00)

Sources: GX-1326

Use of Customer Funds to Pay for Transfer to Modulo Capital

June 27, 2022 – September 26, 2022



private-ventures

SB Sam Bankman-Fried 6/24/2022, 11:33 AM

\$50m for Modulo Capital LP; we should send via signet: S6f2f8298a1ac37eb55d6b61c770949fc843a7239

:paid: 1 • Jen

Tracing Use of Customer Crypto Funds

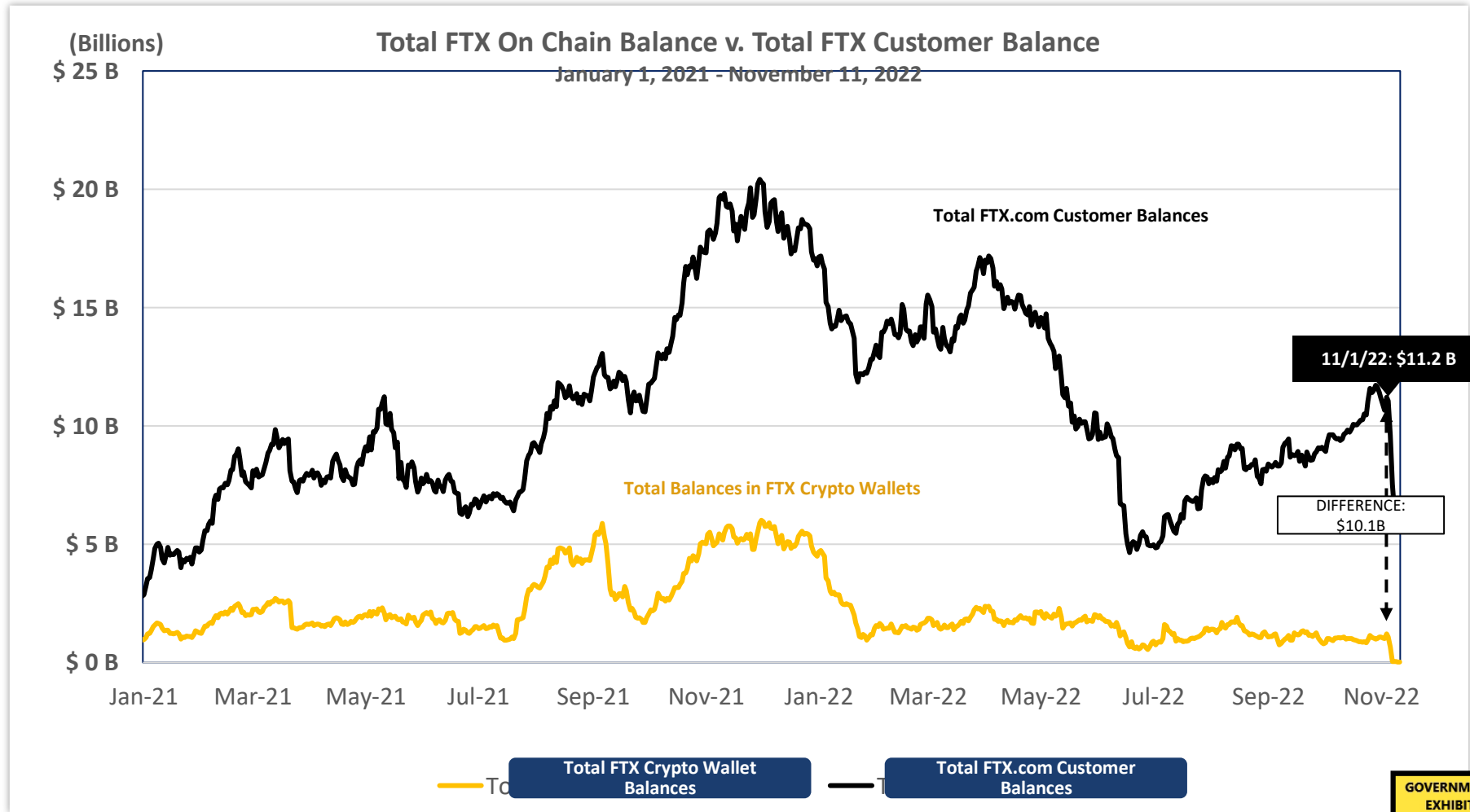

GOVERNMENT EXHIBIT 1051
22 Cr. 673 (LAK)

Sources: FTX.com database; on chain research

Alameda Account with "allow_negative" flag on FTX Exchange

The screenshot shows a database client interface with a SQL query and its results. The query is:

```
select id, user_id, username, liquidating, borrow, allow_negative, can_trade_futures, use_ftt_collateral, ignore_imf_factors, fee_voucher, charge_interest_on_negative_usd, spot_margin_enabled, spot_margin_lending_enabled, account_type from accounts a where id=9 and user_id='auth0|5c7cfd86dd5dae18b1c00d6d' order by 1;
```

The results table shows the following data for the account with ID 9:

id	user_id	username	liquidating	borrow	allow_negative	can_trade_futures	use_ftt_collateral	ignore_imf_factors
9	auth0 5c7cfd86dd5dae18b1c00d6d	info@alameda-research.com	[]	65,355,999,994	[v]	[v]	[v]	[]

The 'allow_negative' flag is highlighted in red in the original image, indicating that this account is allowed to have negative balances.

Alameda Account with "allow_negative" flag on FTX Exchange

The screenshot displays a database management system interface with the following components:

- Query Editor:** Contains the SQL query: `select * from historical_balances hb where account_id=9 and until::date = '2022-11-02';`
- Table Grid:** Shows the results of the query. The first record is highlighted with a red box around the `account_id` column, which contains the value `9`.
- JSON Viewer:** Displays the `balances` column as a JSON object. The object contains multiple entries, with the entry for `"44"` highlighted by a red box and a Bitcoin icon. The value for `"44"` is `"-157500792.1532121705663039"`.

Grid	until	account_id	created_at	balances
1	2022-11-02 00:00:00.000	9	2022-11-03 02:29:06.373	{"1": "-676919581.0846058295811415", "19": "7873", "20": "383.8541357899718028", "21": "65726471", "22": "263097.1989779744086159", "23": "6502.", "24": "10957629872522.69818811655787", "25": "26": "1.4044251688009107", "27": "3.3746922", "28": "3083588232124.608369627298992", "29": "30": "98207629094.1106219360920714", "31": "32": "970.1869283147729990", "33": "10019086", "34": "2617.6263799270106141", "35": "3958.48", "36": "69666844016791.97303259437510", "37": "38": "139.8328103029952091", "39": "11371344", "40": "10.0067247679832935", "41": "12.482866", "43": "-69111.1521644674282096", "44": "-157500792.1532121705663039"}

Source: GX-1734

Balance of Alameda Research Accounts on FTX.com with 'allow_negative' Enabled



(USD, BTC, ETH, USDT)



Use of Customer Crypto Funds from FTX.com

Buyback of FTX Stock from Binance

June 2021 – July 15, 2021

SHARE TRANSFER AGREEMENT

This Share Transfer Agreement (this "Agreement"), dated as of July 15, 2021 is entered into by and between FTX Trading Ltd., a company established under the laws of Antigua and Barbuda ("FTX"), Binance Capital Management Co. Ltd., a company established under the

This Share Transfer Agreement (this "Agreement"), dated as of July 15, 2021 is entered into by and between FTX Trading Ltd., a company established under the laws of Antigua and Barbuda ("FTX"), Binance Capital Management Co. Ltd., a company established under the laws of the British Virgin Islands ("Seller") and Euclid Way Ltd, a company established under the laws of Antigua and Barbuda ("Purchaser").

WHEREAS, Purchaser desires to purchase, and Seller desires to sell, 96,456,750 Series A preferred shares, par value \$0.0000026 per share (the "Transferred Shares") of FTX.

hereby conveys, sells and transfers the Transferred Shares (together with all rights, benefits and privileges of Seller thereunder), as beneficially owned by it, free and clear of claims, liens or other encumbrances, to Purchaser, and Purchaser hereby purchases and accepts the Transferred Shares and all such rights, benefits and privileges. FTX hereby consents to such transfer and waives any

FTX Trading Ltd

By: 

Name: Samuel Bankman-Fried

Title: CEO

Seller, free and clear of any liens, security interests or any other encumbrances;

(b) Purchaser shall transfer good and marketable title to such number of cryptographic tokens with the symbol "FTT" with value equal to US\$554,868,500 in accordance with Section 1.4 to Seller, free and clear of any liens, security interests or any other encumbrances; and

(c) Purchaser shall transfer good and marketable title to such number of cryptographic tokens with the symbol "BNB" with value equal to US\$554,868,500 in accordance with Section 1.4 to Seller, free and clear of any liens, security interests or any other encumbrances.

Message

From: Sam Bankman-Fried [sam@ftx.com]
on behalf of Sam Bankman-Fried <sam@ftx.com> [sam@ftx.com]
Sent: 7/15/2021 12:10:16 PM
To: Brooke Xue [brooke.xue@binance.com]
CC: Wang, David S. [davidwang@paulhastings.com]; Hon Ng [hon.ng@binance.com]; Can Sun [csun@fenwick.com]; Helen Hai [helen.h@binance.com]; danny.f@binance.com; Xiong, Jialing [jialingxiong@paulhastings.com]; susan li [susan.li@binance.com]; Daniel Friedberg [dan@ftx.com]
Subject: Re: **Binance / FTX - closing funds flow memo**

Please transfer:

- 1,764,040.96088 BNB
- 500,000,000 BUSD, in addition to all currently pending BUSD (roughly 571,250,000.00 as of writing)

from: email is evergreennorthernenterprises@gmail.com and UID is 94086678

To: address is bnb136ns6lfw4zs5hg4n85vdthaad7hq5m4gtkgf23, memo is 558635257

please do these transfers if and only if you promise to send both a scan and the hard copy of the necessary notarized documents to us in the next hour.

—
Sam Bankman-Fried

Use of Customer Funds to Buy FTX Stock from Binance

July 2021

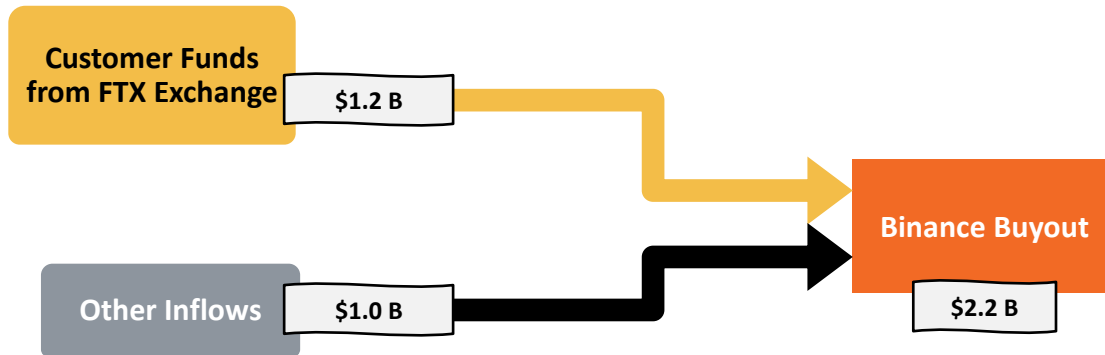

Source of Customer Funds: Alameda FTX Account 1417074
Balance of Account on 7/15/21: -\$1.8 B

Use of Customer Funds to Buy FTX Stock from Binance

July 2021

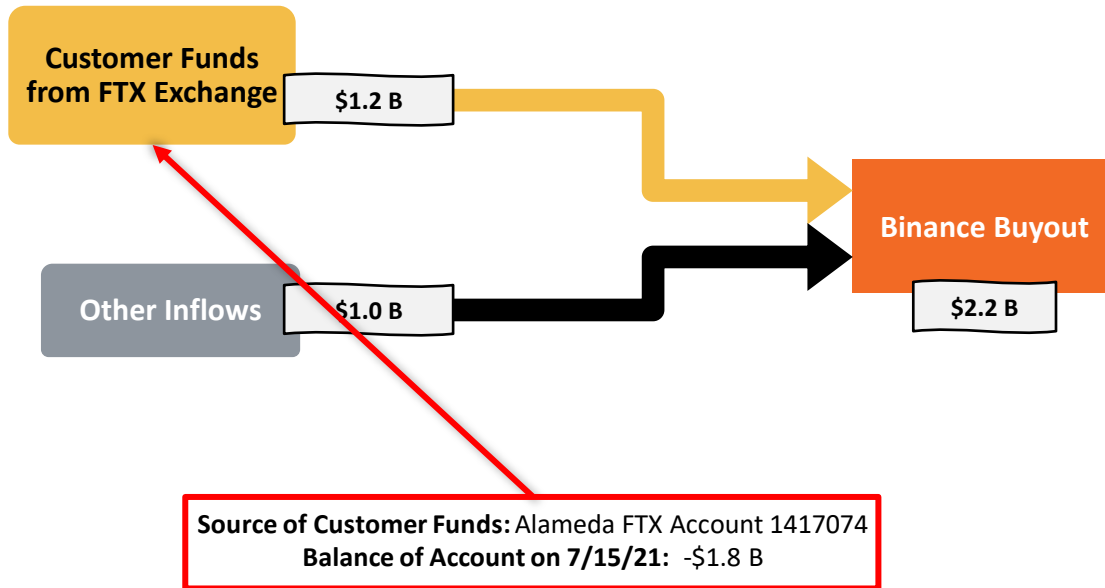

Use of Customer Crypto Funds to Repay Alameda's Lenders

Alameda Borrowing From Third Party Lenders

January 1, 2022 - November 11, 2022

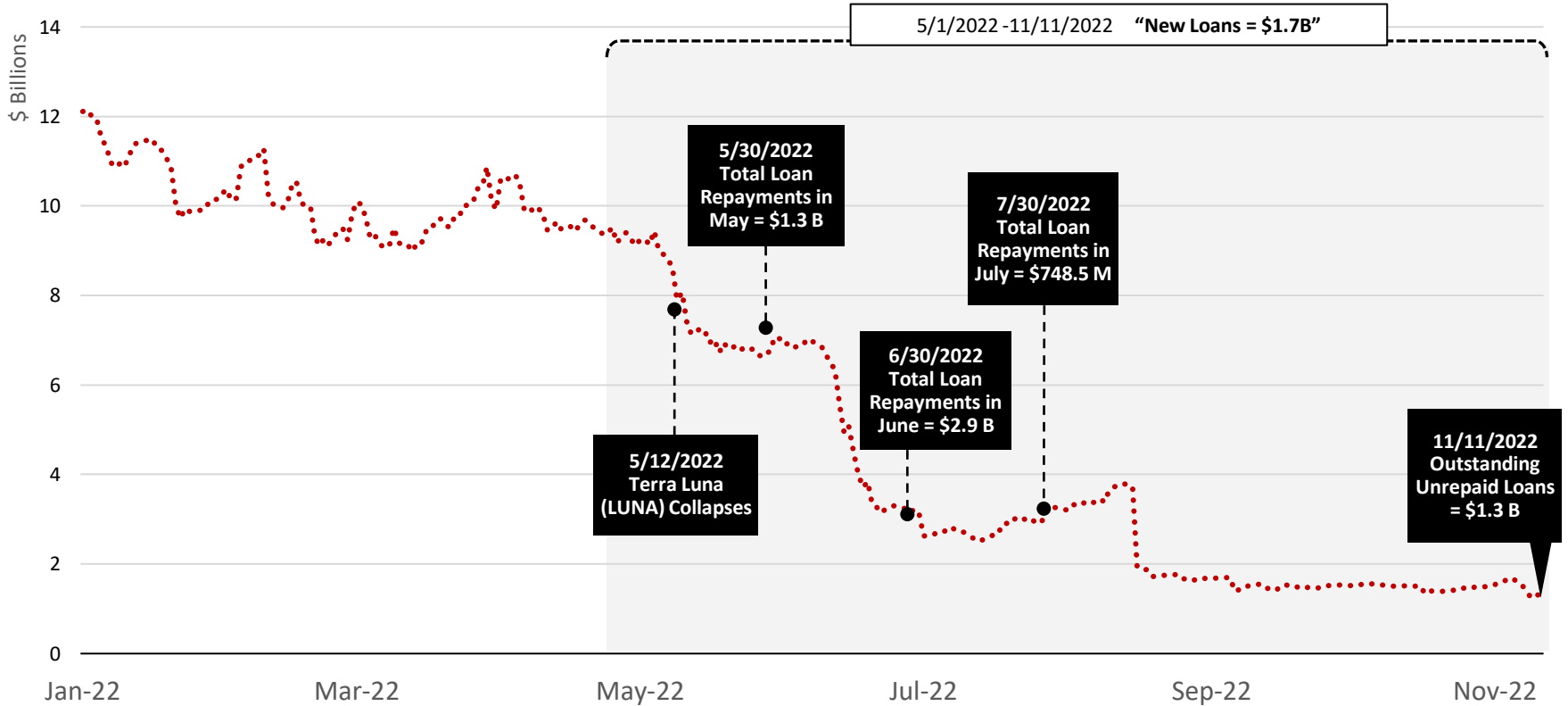

Amount of Alameda's Loans from Crypto Lenders Repaid Using FTX Customer Funds

May - November 2022

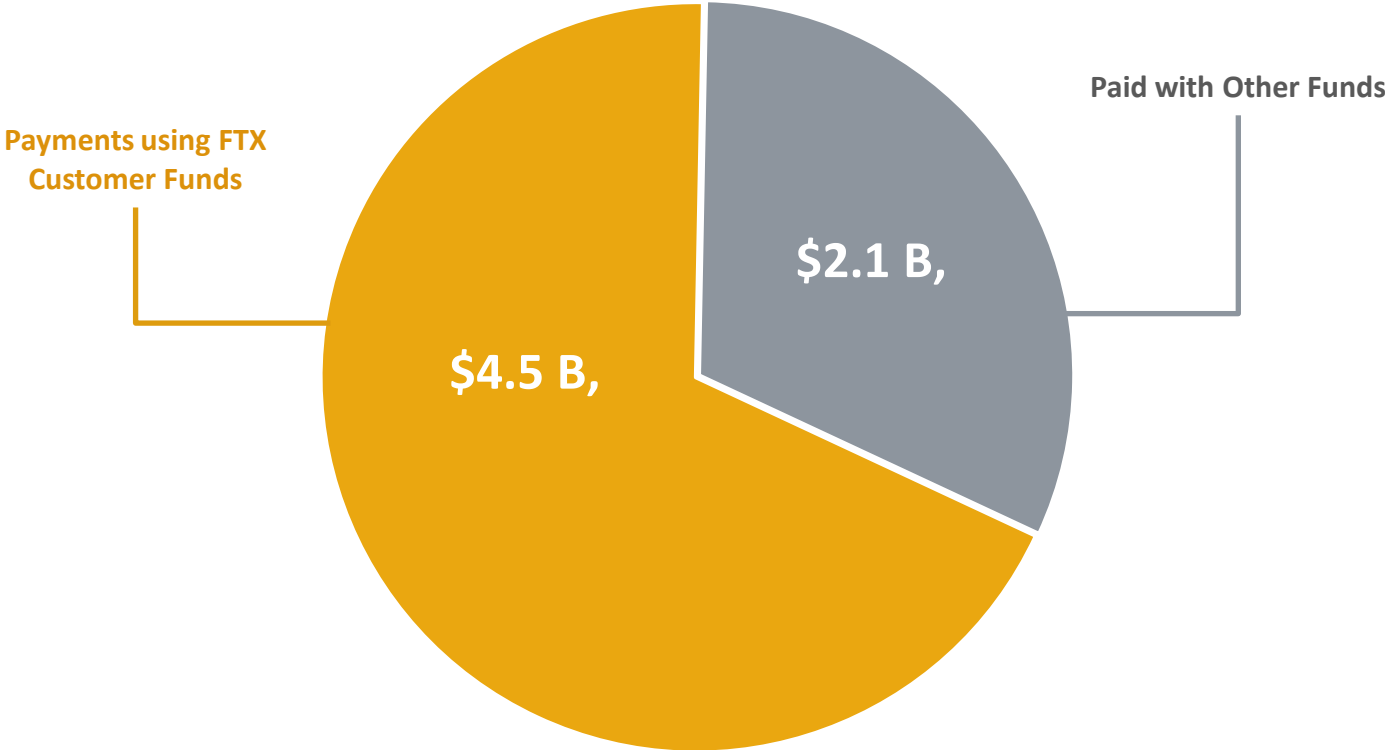

GOVERNMENT EXHIBIT 1018
22 Cr. 673 (LAK)

Sources: GX-4, GX-111, GX-1100, GX-1101, GX-1199, GX-1200, GX-1216, GX-1235, GX-1291, GX-1304, GX-1289, GX-140, GX-108, Bitgo email needs GX#; GX-1718; on chain research