

DRI-EAZ

Owner's Manual Revolution LGR Dehumidifier

Model F413-115V

DRI-EAZ PRODUCTS, INC.

15180 Josh Wilson Road, Burlington, WA 98233

Phone: 800-932-3030 Fax: 360-757-7950 <http://Revo.DriEaz.com>

The Dri-Eaz® Revolution LGR Dehumidifier reduces humidity in enclosed environments by removing water vapor from the air. The Revolution is ideal for water damage restoration, structural drying, construction, and many other applications requiring temporary, high-performance dehumidification.

Patents: <http://www.LBpatents.com>

READ AND SAVE THESE INSTRUCTIONS

WARNING

Read and understand manual before operating.



WARNING! Do not alter or modify your Revolution in any way. Use only replacement parts authorized by Dri-Eaz Products, Inc. Modifications or use of unapproved parts could create a hazard and will void your warranty. Contact your authorized Dri-Eaz distributor for assistance.

WARNING! Electric shock hazard, rotating fan, hot surface hazards. Unplug unit before opening cover for cleaning or servicing.

WARNING! Unit must be grounded.

- Keep motor and wiring dry. Keep out of standing water and do not install in area likely to be subject to water intrusion. Do not expose to rain, water or snow.
- Insert three-prong plug on power cord into a matching electrically grounded outlet. Do not use adapter. Never cut off third prong.
- Do not use an extension cord.
- To reduce the risk of fire or electric shock, do not use this unit with any solid-state speed control device.

FIRE HAZARD

- Keep away from open flames and heat sources.
- Do not use or store where vapors from gasoline, solvents, thinners or other flammable materials may be present.

WARNING! Unplug unit before cleaning or servicing.

- Turn off unit and unplug before lifting or moving.
- Handle the unit carefully. Always operate the unit on a stable, level surface. Do not drop, throw, or place where it could fall. Rough treatment can damage the unit, and may create a hazardous condition or void the warranty.
- Inspect the power cord before use. If cord is damaged, do not use. Always grasp the plug (not the cord) to unplug.
- The unit must be operated on a 115V/60 Hz circuit protected by a Ground Fault Circuit Interrupter (GFCI) device.
- Do not attempt to repair the unit. For Authorized Service Centers, call Dri-Eaz Service at 800-932-3030.

BEFORE YOU BEGIN

Warranty registration

Visit warranty.drieaz.com to register your purchase. Registration allows us to better assist you with using, maintaining or servicing your equipment and to contact you in case we have important safety information concerning your Dri-Eaz product. If you determine service is required, have your equipment model, serial number and original proof of purchase available and call your distributor for assistance with obtaining a return material authorization (RMA).

INTRODUCTION

The Revolution Dehumidifier reduces humidity in enclosed structural environments by removing water vapor from the air. With proper use, the Revolution can help to dry out damp structural materials, insulation, and contents, and maintain a healthy level of humidity. Using the Revolution may also prevent secondary damage caused by high humidity.

How the Revolution works

The Revolution refrigerant dehumidifier uses a fan to draw moist air in and condenses it into water that collects in a tray and is automatically pumped out through a drain hose. The unit can be set to operate continuously or the user may select Humidistat Mode. In Humidistat Mode, the Revolution will turn on and off automatically to maintain the inlet humidity level the user has selected. Note that the fan will operate continuously when the unit is in Humidistat Mode.

Features:

- Industrial-quality dehumidifier removes up to 134 pints (63 liters) of water per day.
- Automatic humidistat to set and maintain desired humidity level.
- Recessed feet indents ensure secure stacking of up to three Revolution units for storage and transport.
- Designed for convenient stacking and transporting on a handtruck.
- Recessed handles for easy positioning in confined spaces.
- Quiet operation and low power consumption.

CONTROLS AND OPERATING INSTRUCTIONS

Set unit upright

NOTICE: Always store, transport, and use the unit in a horizontal position. If the unit is ever placed in a vertical position, return it to the horizontal position and let it stand for at least 30 minutes before turning it on.

Positioning a Dehumidifier

For best results, operate your dehumidifiers in an enclosed area. Close all doors and windows that open to the outside to maximize water removal efficiency. Place your dehumidifier away from obstructions, and keep it away from anything that could block airflow into and out of the unit. For more information about creating an optimum drying environment, contact Dri-Eaz at 800-932-3030.

Set up drain hose

The Revolution condensate pump connects to a plastic drainage hose. This hose is equipped with a quick-connect fitting for quick attachment to the provided 40 ft. (12 m) drain hose. Unwrap the entire hose and place the unattached end in a sink, drain, bucket or outdoors – anywhere that water can drain out safely. If you use a bucket or other container for water collection, check it regularly to prevent overflows.

NOTICE: Uncoil and straighten the entire drain hose. Do not leave any part of the hose coiled and do not place

Fig. A: Parts Identification

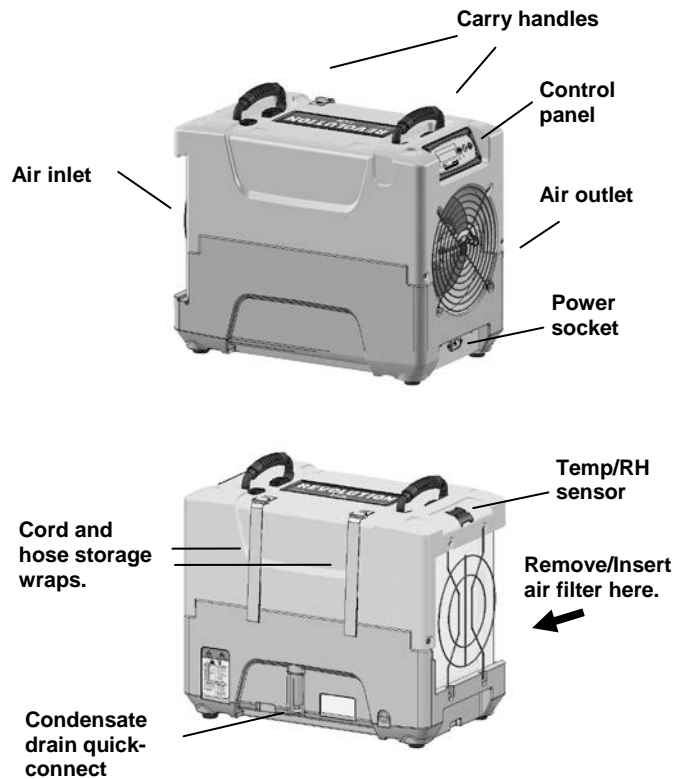

the end of the hose higher than 20 ft. (6 m) above the bottom of the unit. Also check for kinks or other obstructions that might restrict the flow of water. Obstructions may cause a water backup and result in overflows.

Plug in electrical cord

The Revolution should be plugged into a GFCI-protected 115 volt outlet rated for at least 15 amps. Always plug the cord firmly into the unit first, and then plug the other end into a suitable outlet.

Startup display and normal display modes

When unit is first plugged in to AC power, the control panel display will briefly cycle through a series of readouts. This is part of the unit's self-diagnosis procedure and no user intervention is required.

Turn the unit on

The control panel on the Revolution dehumidifier has a display and a touchpad with four keys. Press the **ⓘ**

ON/OFF to turn the unit on. The unit will now go through a compressor delay countdown (up to sixty seconds in duration) and a self diagnostics process.



Once the compressor delay countdown and self-diagnostics are complete, the display will switch to **normal display mode**.

UNIT ON 00 HRS
INLET 00°C / INLET 00%

The **first line** of the display shows the total number of hours the unit has been in operation. This value may be

reset to zero to track job hours (see “Job Hours Reset” below). The **second line** of the display alternates between inlet temperature and inlet humidity.

User Settings Menu

A number of display settings may be changed by the user. System information can also be displayed. These items are accessed by pressing  DISPLAY MENU. Each press of the key will display the next parameter. When you reach the parameter you wish to adjust, press  MENU SELECTION to increase the value. Press  DISPLAY MENU again to accept the setting and re-start the display cycle. If no keys are selected for 5 minutes the display will automatically reset and return to the normal display mode.

CONTROL PANEL

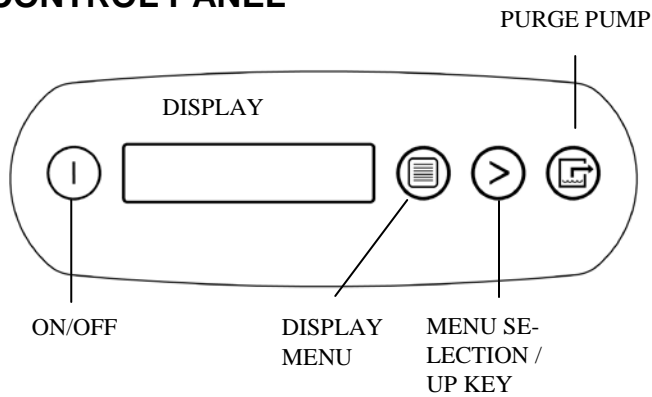

ON/OFF	Press and release to turn unit on or off.
DISPLAY MENU	Press to select next item in menu. Menu item will show in display.
MENU SELECTION / UP KEY	Press to toggle or select values in menu displayed.
PURGE PUMP	Press and release to start purge. Display will count down seconds remaining until purge is complete.

Note that only menu items followed by a greater-than symbol (>) may be adjusted.

All settings and modes are discussed in detail in Control Panel Guide, below.

Error messages

If the Revolution onboard diagnostics discover a problem, the unit will display an error message. See “System Messages,” p. 6 for an explanation of each message.

Control Panel Guide

1 ON/OFF. Press to turn the unit on or off. When the machine is turned on, the display normally reads PLEASE WAIT COMP. DELAY and performs a numeral countdown for a maximum of 60 seconds to 0. This delay allows time for refrigerant pressures to equalize for easier starting. Once the unit completes the compressor



delay, the display shows UNIT ON XX HRS and cycles between INLET XX°F and INLET XX%. NOTE: If no compressor delay countdown is displayed, a delay is not necessary and the machine will begin operation immediately.

 **DISPLAY MENU.** Press to cycle through the display of additional dehumidifier conditions and User Settings. To return to the main menu, press the ON/OFF key once.

 **MENU SELECTION.** Press to change the values of the "User Defined" settings. The MENU SELECTION key acts as the UP key for adjusting the setpoint for Humidistat mode operation. See User Settings Menu (below) for details.

 **PURGE.** Press to empty water from the condensate pump reservoir. The display will read PUMP PURGING with a numeral countdown. NOTE: During normal operation, the pump purges automatically every 20 minutes, or whenever the reservoir is full.

Changing settings and viewing system information

Display setting changes and system information can be accessed by pressing  DISPLAY MENU. Each press of the key will display the next parameter (see list below). When you reach the parameter you wish to adjust, press  MENU SELECTION to increase the value. Press  DISPLAY MENU again to accept the setting and re-start the display cycle. If no keys are selected for 5 minutes the display will automatically reset and return to the normal display mode.

Note that only menu items followed by a greater-than symbol (>) may be adjusted.

**JOB HOURS
RESET? >**

Press  MENU SELECTION to reset hours to zero. NOTE: When in Humidistat mode, the unit will display HUMIDISTAT on the top line during normal operation rather than JOB HOURS.

**LIFE HOURS
00 HRS**

Shows total unit operating hours. Value cannot be modified.

**INLET OUTLET
00° 00% 00° 00%**

Shows current temperature and RH of inlet and outlet.

Normal Operation

The default operating mode keeps the dehumidifier running at its maximum capacity. This is ideal for most restoration application To control humidity at a

specific level, choose Humidistat Mode, described below.

Humidistat Mode

HUMIDISTAT MODE ON/OFF >

In ON mode, unit will maintain the humidistat setpoint (see below). Press **>** MENU SELECTION to toggle between ON and OFF. NOTE: When in Humidistat mode, the unit will display HUMIDISTAT on the top line during normal operation rather than JOB HOURS.

HUMIDISTAT SETPOINT 00% >

Sets humidity level when unit is in Humidistat Mode. Press **>** MENU SELECTION to change RH value. Each press of the button increases the setting by 5% increments, cycling through 90%RH and starting again at 40%RH.

TEMP UNITS F° >

Shows current temperature scale. Press **>** MENU SELECTION to select Fahrenheit or Centigrade scale.

LANGUAGE ENGLISH >

Shows current display panel language. Press **>** MENU SELECTION to select Spanish, German, French or English.

COIL TEMP 00°F

Displays the cold (evaporator) coil temperature.

SENSOR ID > 0000000

This function is not used on the Revolution.

COMPRSSR CURRENT 0.0 A

Shows compressor current draw in amps.

AT THE END OF THE JOB

To reduce the possibility of drips when moving the unit, follow these additional steps to ensure that all water is removed from the unit.

NOTICE: To ensure the condensate tank empties completely while purging, make sure the unit is positioned horizontally on a flat surface.

1. If the unit is in a defrost cycle, wait until the unit has returned to normal operating mode before proceeding. To check, review the control panel. The control panel will show one of the following:

Defrost in progress:

UNIT ON 00 HRS DEFROST XX

Display mode when unit is in defrost mode. XX indicates the minutes remaining on the defrost cycle.

Shutdown Sequence

WAIT FOR DEFROST XX

Display mode when unit is in defrost and is powered down by the user. Unit will complete the defrost cycle to remove any built-up ice and then purge the pump. XX indicates the minutes remaining on the defrost cycle.

Normal Display:

UNIT ON 00 HRS INLET XX° F

Wait until the control shows the *normal display* before proceeding.

2. Gently rock the machine to ensure any water remaining on interior surfaces falls into the sump area.

3. Press the **PURGE** key. When the purge cycle is complete, turn the unit off.

4. Remove the external drain hose, drain it carefully, coil it and secure it with one of the Velcro straps provided on the side of the unit.

5. Unplug power cord from power supply and from base of the machine, coil neatly, coil it and secure it with one of the Velcro straps provided on the side of the unit. (see Fig. A).

TRANSPORTATION AND STORAGE

NOTICE: Handle the unit carefully. Do not drop, throw, or place the unit where it could fall. Rough treatment can damage this equipment and may create a hazardous condition or void warranty.

- Do not expose the control panel to moisture, snow or rain.
- Protect from freezing.
- Store and transport securely to avoid any damaging impact to internal parts.
- Secure during transport to prevent sliding and possible injury to vehicle occupants.

MAINTENANCE SCHEDULE

WARNING! ELECTRIC SHOCK HAZARD. Unplug unit before cleaning or servicing.

WARNING: Risk of dust and contaminants exposure. Use of respirator mask and gloves is recommended. If unit has been exposed to potentially dangerous contaminants, clean thoroughly and sanitize before reuse.

NOTICE: The unit is fitted with sensitive electronic sensors. Protect the sensors and their lead wires from damage and do not expose them to water or cleaning solution.

The following tools and supplies are needed to complete the maintenance procedures described in this manual:

- Philips screwdriver
- 10 mm wrench
- 6 mm hex bit
- ¼ in. nut driver
- Cleaning cloths
- HEPA vacuum cleaner with soft brush nozzle and crevice nozzle.

Recommended

Cordless drill, small knife, small-jaw pliers, coil cleaning solution, rotomolded housing cleaning solution.

Before each use

Inspect the electrical cord for damage. Look for fraying, cuts, etc. Replace the cord if you find any damage.

Inspect, vacuum or replace filter. The Revolution is provided with a 3M™ HAF High Air Flow filter (part no. F372). HAF filters **may be vacuumed clean and reused up to three times before replacement.** Use a HEPA vacuum and brush tool to remove any dust or debris. Do not use compressed air or expose the filter to any liquids, as may damage the filter.

Monthly

Inspect coils. Clean when dust accumulation is visible. In normal use, dust can accumulate and can restrict airflow, reducing performance and causing the unit to overheat. Use a vacuum cleaner with a brush tool and a soft cloth to remove any debris. Take care not to damage any interior components.

To maintain appearance, wipe interior and exterior surfaces with a damp cloth. For deep cleaning and a lasting, protective shine, use an automotive interior cleaner.

As Needed

Clean pump check valve and basin. If the unit displays the message “ER9 PUMP BLOCKED CHECK PUMP &

Fig. B: Disassembly for Cleaning

Remove the 4 screws from housing and 2 top screws each from inlet and outlet grills and lift off cover.

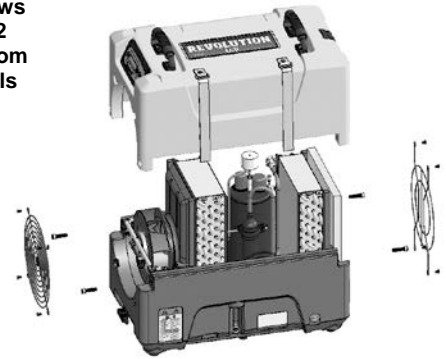

HOSE”, the pump check valve and pump basin may need to be cleaned. Remove grills and cover as shown in Fig. B. Remove screws from pump base and lift out pump. Wipe out pump basin with a damp cloth. Inspect the pump base for build-up of debris and clean if needed. Unthread barbed fitting with check valve and rinse fitting and check valve with clean water. Reinstall check valve into barbed fitting and install the barbed fitting into pump. Do not overtighten. Reinstall pump on base. Reinstall cover and grills.

Clean coils. Inspect the horizontal evaporator (cold) coil with the cover removed. If excessive dust and debris is present, vacuum thoroughly and/or clean with coil cleaner.

ABOUT 3M™ HIGH AIR FLOW FILTERS

HAF filters from 3M provide superior particle retention, resist microbial growth on filter surfaces and allow for maximum airflow throughout the filter loading cycle. Follow these guidelines to ensure maximum protection for equipment, technicians and the job site:

Replace the HAF filter whenever it has been vacuumed clean and reused three times. HAF filters lose their effectiveness after three uses.

Replace the HAF filter whenever it has been used on a mold remediation job or otherwise exposed to potentially dangerous contaminants. Continued use of a contaminated filter risks the spread of contamination.

Do not wash or apply any liquids to the HAF filter. Exposure to liquids will reduce the effectiveness of the electrostatic material.





Do not operate without the HAF filter in place. Do not operate the unit with any other filter type. Incorrect filtration will reduce unit efficiency and can cause damage to the unit.

Use the optional mesh filter when excessive dust or airborne particles are present. High volumes of particulates present during sanding, spray painting, or similar operations can clog the unit and cause damage.

System messages

The Revolution control system constantly monitors internal operating conditions. If the system detects a problem, it will produce an error (“ER”) message. If the display shows an ER message, first unplug the unit and then plug it back in. This will usually reset the electronics, and the unit will begin operating normally. If the error message reappears, refer to the explanation and solution shown below. If this still does not fix the problem, contact your local authorized service center or call the Dri-Eaz Service Department at 800-932-3030.

NOTE: The message “POWER FAILURE” is not a system error. When this message is displayed, it indicates that power to unit was interrupted and then restored. To clear the message, press the  MENU SELECTION key.

CONTROL PANEL MESSAGE	EXPLANATION AND SOLUTION
ER1 CONTACT SERVICE CENTER	Voltage error. Confirm that unit is connected to a suitable AC power supply and that the circuit is not overloaded. If supply is correct, the electronic control panel may require replacement. If error persists, contact service.
ER2 CONTACT SERVICE CENTER	Control panel error. The electronic control panel may require replacement. If error persists, contact service.
ER3 CONTACT SERVICE CENTER	Unit in defrost too long. Check defrost sensor cable for proper connection. If error persists, sensor assembly may require replacement. Contact service.
ER4  DEFROST SENSOR CONNECT – <i>alternate message</i> – ER4  OUTLET SENSOR CONNECT	Sensor error. Check defrost sensor cable for proper connection. If error persists, sensor assembly may require replacement. Contact service.
ER5  SENSOR CONNECTION ON BD	Check inlet Temp/RH sensor for proper connection. If error persists, contact service.
ER6 CONTACT SERVICE CENTER	High voltage error. The high voltage board may require replacement. If error persists, contact service.
ER7 INVALID MODEL SETTING	Control board DIP switch settings or firmware version may be incorrect. If error persists, contact service. Service may ask you to verify DIP switch settings.
ER8 BUTTON STUCK  ALL BUTTONS	Press each membrane key and check for proper operation. If a key doesn’t function, or if the error persists, the membrane overlay may require replacement. Contact service.
ER9 PUMP BLOCKED  CHECK PUMP & HOSE	Check for obstructions in drain hose. If clogged, remove hose from unit and blow hose out with compressed air. Inspect and clean the pump check valve and pump basin. See “Clean pump check valve and basin,” p. 5.

TROUBLESHOOTING

FAULT	CAUSE	SOLUTION
Water drips out when moving unit	Unit was unplugged before purging was complete.	Purge unit before moving. See "At the End of the Job," p. 4.
Unit does not operate	Unit not switched on. No power to machine.	Switch unit on. Plug in unit; check power cord connection at wall outlet and at base of unit.
Unit operating, but room not dry	Not enough time to dry. Poor air movement in room. Excessive moist air infiltration.	Allow more time for drying. Increase air movement with air movers. Seal off area to reduce infiltration.
Unit collects too little water	Room air is dry. Room temperature is too low. Filter is clogged. Coils are clogged.	Confirm humidity level with hygrometer. Increase room temperature. Check filter. Clean or replace as necessary. Check coils. Clean as necessary.
<p><i>If the problem you are experiencing is not listed here, call your local distributor or contact our Service Department toll-free at 800-932-3030 for further assistance.</i></p>		

SPECIFICATIONS

Name	Revolution LGR Dehumidifier Model F413-115V
Dimensions (W x H x D)	12.5 x 17.6 x 21.5 in. 31.8 x 44.7 x 130.8 cm
Weight (w/ cord & hose)	65 lbs. 29.5 kg
Amps	6.2 amps at 80°F/60% RH
Power	115V / 60Hz
Air movement	121–180 CFM 3.43–5.1 CMM
Water removal	80 pts/day 38 L/day at 80°F/60% RH (AHAM) 134 pts/day 63 L/day at 90°F/90% RH
Operating temperature range	33–100°F 1–38°C
<p><i>Specifications are subject to change without notice. Some values may be approximate.</i></p>	

PARTS INCLUDED

40 ft. (12 m) of drain hose with quick-connect fitting.
25 ft. (7.6 m) detachable power cord.
3M™ HAF High Air Flow filter reorder no. F372 (24 pack)

ADDITIONAL PRODUCT INFORMATION and current documentation is available at <http://Revo.DriEaz.com>.

FOR PARTS AND SERVICE CALL YOUR LOCAL DISTRIBUTOR or Dri-Eaz at 800-932-3030.
www.dri-eaz.com

Visit warranty.DriEaz.com and register your purchase to ensure you receive any important product releases.

DRI-EAZ LIMITED WARRANTY

Evolution LGR, DrizAir 1200, LGR 2800i, LGR 3500i, LGR 7000XLi and Revolution LGR

This Warranty is provided to the original purchaser only and covers only products purchased by the original purchaser from an authorized Dri-Eaz distributor.

How Long Does This Warranty Last?

This warranty runs for:

- Lifetime from the date of purchase on polyethylene body;
- Six (6) years from the date of purchase on the compressor and coils;
- One (1) year from the date of purchase on parts and labor (EXCEPT this warranty does not cover consumable or wear items including, but not limited to, filters, batteries, power cords, belts, cords, switches, valves, hoses, and rubber parts);

What Dri-Eaz Will Do:

If a defect in materials or workmanship occurs within the warranty period for a product purchased by you from an authorized distributor, Dri-Eaz at its election will repair or replace the defective part at no charge.

What This Warranty Does Not Cover:

This warranty does not cover or apply to damage or defects due directly or indirectly to misuse, abuse, disassembly, alteration, use of non-Dri-Eaz filters, corrosive chemicals, improper voltage, fire, flood, negligence, accident, improperly or incorrectly performed maintenance or repair, or failure to perform necessary or recommended maintenance or repair (See your Owner's Manual) or if the use of this product is not in compliance with the instructions and specifications for its use. This warranty does not cover filters. We limit all implied warranties to:

- Lifetime from the date of purchase on polyethylene body;
- Six (6) years from the purchase date on the sealed refrigeration system;
- One (1) year from the purchase date on parts and labor (EXCEPT this warranty does not cover consumable or wear items including, but not limited to, filters, batteries, power cords, belts, cords, switches, valves, hoses, and rubber parts).

OTHER THAN THE WARRANTIES PROVIDED HEREIN, DRI-EAZ MAKES NO EXPRESS OR IMPLIED, ORAL OR WRITTEN WARRANTIES WITH RESPECT TO THIS PRODUCT OR WORKMANSHIP AND ALL WARRANTIES IMPLIED BY LAW INCLUDING ANY WARRANTIES OF MERCHANTABILITY OR FITNESS FOR A PARTICULAR PURPOSE ARE LIMITED TO THE DURATION OF THIS WARRANTY. Some states do not allow limitations on how long an implied warranty lasts, so the above limitations may not apply to you. **WE SHALL IN NO EVENT BE LIABLE FOR DEATH, INJURIES TO PERSONS OR PROPERTY OR FOR INCIDENTAL, CONTINGENT, SPECIAL OR CONSEQUENTIAL DAMAGES ARISING FROM USE OF OUR PRODUCTS.** Some states do not allow the exclusion or limitation of incidental or consequential damages, so the above limitation or exclusion may not apply to you.

How Do I Get Service?

In order to be eligible for service under this warranty you MUST do the following: (a) visit warranty.drieaz.com and register your purchase to ensure you receive any important product releases; (b) write or call for a return material authorization (RMA); and (c) have the serial number and original proof of purchase available. Contact us at:

Dri-Eaz Products, Inc.
360-757-7776 or 800-932-3030
15181 Josh Wilson Road
Burlington, WA 98233

We will inspect the product without charge and contact you within 72 hours of our receipt of the product to give you the results of our inspection. If our inspection uncovers a defect we will repair or replace the product, at our election. If the product is returned to us on or before ninety (90) days from the date of purchase, we will pay for the cost of shipping it to Dri-Eaz and the cost to return it to you. If the product is returned to us after the expiration of ninety (90) days from the date of purchase, all shipping costs shall be paid by the purchaser.

If it is determined that there is no defect in the product, or that the defect resulted from causes not within the scope of our warranty, then the product will be repaired or replaced only at your request and at your expense and you must bear all shipping costs.

How Does State Law Apply?

This warranty gives you specific legal rights, and you may also have other rights which vary from state to state.

GARANTÍA LIMITADA DE DRI-EAZ

Evolution LGR, DrizAir 1200, LGR 2800i, LGR 3500i, LGR 7000XLi y Revolution LGR

Esta garantía se ofrece únicamente al comprador original y sólo cubre los productos comprados por el comprador original de un distribuidor autorizado Dri-Eaz.

¿Cuánto tiempo dura esta garantía?

Esta garantía dura:

- Vida útil desde la fecha de compra con cuerpo de polietileno;
- Seis (6) años a partir de la fecha de compra en el caso del compresor y de las bobinas;
- Un (1) año a partir de la fecha de compra en el caso de las piezas y la mano de obra (EXCEPTO que esta garantía no cubre los consumibles o piezas de desgaste, incluyendo, pero no limitado a, filtros, baterías, cables de alimentación, cinturones, cordones, interruptores, válvulas, mangueras y elementos de goma).

Dri-Eaz realizará lo siguiente:

Si un defecto en los materiales o la fabricación dentro del período de garantía de un producto adquirido por usted de un distribuidor autorizado, Dri-Eaz a su elección, reparará o reemplazará la pieza defectuosa sin costo alguno.

¿Qué no cubre esta garantía?

Esta garantía no cubre o no se aplica a los o defectos defectos que se produzcan como consecuencia directa o indirecta del uso inadecuado, mal uso, realización incorrecta del montaje, alteración, uso de filtros no Dri-Eaz, químicos corrosivos, voltaje incorrecto, fuego, inundación, negligencia, accidente, reparación o mantenimiento realizados de manera impropia o incorrecta o la no realización de la reparación o mantenimiento necesarios o recomendados (consulte el Manual del propietario) o si se utiliza este producto sin cumplir con las instrucciones y especificaciones para su uso. Esta garantía no cubre filtros. Limitamos toda garantía implícita a:

- Vida útil desde la fecha de compra con cuerpo de polietileno;
- Seis (6) años a partir de la fecha de compra del sistema de refrigeración sellado herméticamente;
- Un (1) año a partir de la fecha de compra en el caso de las piezas y la mano de obra (EXCEPTO que esta garantía no cubre los consumibles o piezas de desgaste, incluyendo, pero no limitado a, filtros, baterías, cables de alimentación, cinturones, cordones, interruptores, válvulas, mangueras y elementos de goma).

A DIFERENCIA DE LAS GARANTÍAS PRESENTES EN ESTE DOCUMENTO, DRI-EAZ NO ASUME GARANTÍA ALGUNA EXPRESADA O IMPLÍCITA, SEA ORAL O ESCRITA CON RESPECTO A ESTE PRODUCTO O LA FABRICACIÓN Y TODAS LAS GARANTÍAS IMPLÍCITAS POR LEY, ENTRE ELLAS TODAS LAS GARANTÍAS DE COMERCIABILIDAD O ADECUACIÓN PARA UN PROPÓSITO PARTICULAR ESTÁN LIMITADAS A LA DURACIÓN DE ESTA GARANTÍA. Algunos estados no permiten limitaciones respecto a la duración de una garantía implícita, por lo que las limitaciones expuestas anteriormente no pueden ser aplicables a usted. **NO SEREMOS RESPONSABLES POR LA MUERTE O DAÑOS A PERSONAS O PROPIEDADES O POR LOS DAÑOS O PERJUICIOS DIRECTOS, INDIRECTOS, ESPECIALES O CONTINGENTES QUE SE DERIVEN DEL USO DE NUESTROS PRODUCTOS.** Algunos estados no permiten la exclusión o limitación de daños y perjuicios directos o indirectos, de modo que la limitación o exclusión expuestas anteriormente no pueden no ser aplicables a usted.

¿Cómo puede conseguir este servicio?

Para que tenga derecho a recibir el servicio dispuesto en esta garantía, usted DEBE realizar lo siguiente: (a) visite warranty.drieaz.com y coloque su compra para asegurarse que usted recibe cualquier lanzamiento de producto importante; (b) escribir o llamar para obtener una Autorización para material devuelto (RMA, por sus siglas en inglés) y (c) tener disponible el número de serie y la prueba de compra original. Contáctese con nosotros al:

Dri-Eaz Products, Inc.
360-757-7776 o 800-932-3030
15181 Josh Wilson Road
Burlington, WA 98233

Examinaremos el producto sin costo y nos pondremos en contacto con usted dentro de 72 horas a partir del momento en que recibamos el producto para entregarle los resultados de nuestra inspección. Si nuestra inspección descubre un defecto, lo repararemos o reemplazaremos el producto, a nuestra elección. Si nos devuelve el producto dentro de o antes de los noventa (90) días a partir de la fecha de compra, pagaremos el costo de envío hacia Dri-Eaz y de vuelta hacia usted. Si se nos devuelve el producto después de la fecha de expiración de noventa (90) días a partir de la fecha de compra, todos los costos de envío los deberá pagar el comprador.

Si se determina que no existe defecto en el producto o que el defecto es resultado de causas que no se encuentran establecidas en esta garantía, el producto se reparará o reemplazará sólo si usted lo solicita y asume el costo y además deberá hacerse cargo de los costos de envío.

¿Cómo se aplica la ley del estado?

Esta garantía le otorga derechos legales específicos y también podría ejercer otros derechos que varían de estado en estado.

GARANTIE LIMITÉE DE DRI-EAZ

Evolution LGR, DrizAir 1200, LGR 2800i, LGR 3500i, LGR 7000XLi et Revolution LGR

Cette garantie est offerte à l'acheteur original et ne couvre que les produits achetés par l'acheteur initial d'un distributeur Dri-Eaz autorisé.

Quelle est la durée de la présente garantie ?

La présente garantie est valide

- À vie à partir de la date d'achat inscrite sur le corps en polyéthylène ;
- pendant six (6) ans à partir de la date de l'achat pour le compresseur et les serpentins ;
- pendant un (1) an à partir de la date de l'achat pour les pièces et la main d'œuvre (SAUF cette garantie ne couvre pas les consommables ou de porter des objets, y compris, mais sans s'y limiter, les filtres, batteries, cordons d'alimentation, ceintures, cordons, commutateurs, vannes, tuyaux et pièces en caoutchouc).

Ce que Dri-Eaz s'engage à faire :

Si un défaut de matériaux ou de fabrication a lieu dans la période de garantie pour un produit que vous avez acheté auprès d'un distributeur agréé, Dri-Eaz à son choix réparer ou remplacer la pièce défectueuse sans frais.

Limitations de la présente garantie :

Cette garantie ne couvre ni ne s'applique aux dommages ou défauts dus directement ou indirectement à une utilisation abusive, désassemblage, la modification, l'utilisation de filtres non-Dri-Eaz, des produits corrosifs, un voltage inadéquat, un incendie, une inondation, la négligence, un accident, l'entretien ou la réparation incorrecte ou mal exécutée (voir le manuel d'utilisation) ou si le produit n'est pas utilisé conformément aux instructions et aux stipulations qui s'y rapportent. Cette garantie ne couvre pas les filtres. Nous limitons toutes les garanties implicites à :

- À vie à partir de la date d'achat inscrite sur le corps en polyéthylène ;
- six (6) ans à partir de la date de l'achat pour le système frigorifique hermétique ;
- un (1) an à partir de la date de l'achat pour les pièces et la main d'œuvre (SAUF cette garantie ne couvre pas les consommables ou de porter des objets, y compris, mais sans s'y limiter, les filtres, batteries, cordons d'alimentation, ceintures, cordons, commutateurs, vannes, tuyaux et pièces en caoutchouc).

AUTRE QUE LES PRÉSENTES GARANTIES, DRI-EAZ NE FAIT AUCUNE GARANTIE EXPRESSE OU IMPLICITE, ORALE OU ÉCRITE RELATIVE À CE PRODUIT OU À LA FABRICATION ET TOUTE GARANTIE, IMPLICITE EN VERTU DE LA LOI, DE QUALITÉ MARCHANDE ET DE CONFORMITÉ À UN USAGE PARTICULIER EST RESTREINTE À LA DURÉE DE CETTE GARANTIE. Certaines provinces n'autorisent pas de limitation de clauses ni de durée ; par conséquent, les présentes limitations ne s'appliquent peut-être pas à vous. **NOUS N'ACCEPTONS AUCUNE RESPONSABILITÉ POUR LA MORT, LES BLESSURES, LES DÉGÂTS OU POUR DES DOMMAGES INDIRECTS, PARTICULIERS, CONSÉCUTIFS OU RÉSULTANTS DE L'USAGE DE NOS PRODUITS.** Certaines provinces n'autorisent pas l'exclusion ou la limitation des dommages consécutifs ou indirects ; par conséquent, cette présente limitation ne s'applique peut-être pas à vous.

Comment obtenir le service ?

Pour obtenir le service en vertu de la présente garantie, vous devez OBLIGATOIREMENT faire ce qui suit : (a) visitez warranty.drieaz.com et enregistrez votre achat pour s'assurer que vous recevez toutes les mises en vente du produit importantes ; (b) écrire ou téléphoner pour obtenir une autorisation de renvoi (AR) et (c) avoir à votre disposition le numéro de série et la preuve d'achat originale. Communiquez avec nous aux coordonnées suivantes :

Dri-Eaz Products Inc.
360-757-7776 ou 800-932-3030
15181 Josh Wilson Road
Burlington, WA 98233 USA

Nous inspecterons le produit sans frais et nous vous communiquerons les résultats de notre inspection dans les 72 heures de la réception du produit. Si nous découvrons une défectuosité, nous choisirons soit de la réparer, soit de remplacer le produit. Si le produit nous est renvoyé dans les quatre-vingt-dix (90) jours de la date de l'achat, nous assumerons les frais de transport aller-retour. Si le produit nous est renvoyé après les quatre-vingt-dix (90) jours de la date de l'achat, tous les frais de transport seront la responsabilité de l'acheteur.

Si on ne constate aucune défectuosité, ou si la défectuosité est le résultat de causes qui ne sont pas couvertes par la présente garantie, le produit ne sera réparé ou remplacé que si vous en faites la demande, et cela, à vos frais y compris le transport.

Effet des lois provinciales

La présente garantie vous donne certains droits et vous en avez peut-être d'autres en vertu des différentes lois provinciales.