



UNIVERSITY OF TORONTO AT MISSISSAUGA
MASTER PLAN - FINAL DRAFT

STERLING FINLAYSON ARCHITECTS
GUNTA MACKARS LANDSCAPE ARCHITECTURE
READ VOORHEES AND ASSOCIATES LTD.
ROWAN WILLIAMS DAVIES & IRWIN INC.
STANTEC CONSULTING INC.

JUNE 1, 2000

| TABLE OF CONTENTS | | Page | | | |
|-------------------|---|------|-----|--|----|
| 1.0 | Executive Summary | 2 | 4.0 | Campus Description | 52 |
| | 1.1 Key Elements of the Master Plan | 3 | 4.1 | Regulatory Issues | 52 |
| | 1.2 Implementation | 4 | 4.2 | UTM Plant / Site Services Evaluation | 54 |
| 2.0 | Background | 5 | 5.0 | Appendix | 56 |
| | 2.1 History | 6 | 5.1 | Existing Structures | 56 |
| | 2.2 Master Plan Issues | 7 | 5.2 | Landscape Assessment | 58 |
| 3.0 | Master Plan | 10 | 5.3 | Recommended Next Steps | 61 |
| | 3.1 Vision | 10 | 5.4 | Master Plan consultation process / Committee Members | 61 |
| | 3.2 Goals | 10 | 5.5 | Directives from the Steering Committee | 62 |
| | 3.3 Projected Growth | 11 | 5.6 | List of Meeting Reports | 62 |
| | 3.4 Land Use | 13 | 5.6 | List of Reference Documents | 63 |
| | 3.5 Parcel Plan | 15 | | | |
| | 3.6 New Building Envelopes and Design Principles | 17 | | | |
| | 3.6.1 Heights, Build-to Lines and Microclimate | 19 | | | |
| | 3.6.2 Landsaped Spaces | 21 | | | |
| | 3.6.3 Pedestrian Circulation | 23 | | | |
| | 3.6.4 Residence Phases 7 & 8 Parcel Description | 24 | | | |
| | 3.6.5 CCIT Parcel Description | 25 | | | |
| | 3.7 Built Form Issues | 26 | | | |
| | 3.8 Ecological Principles | 28 | | | |
| | 3.9 Landscape Goals | 29 | | | |
| | 3.10 Open Spaces | 32 | | | |
| | 3.11 Microclimate | 33 | | | |
| | 3.12 Traffic, Vehicular / Pedestrian Circulation, Parking | 36 | | | |
| | 3.13 Servicing | 42 | | | |
| | 3.14 General Program Distribution | 45 | | | |
| | 3.15 Funded Buildings | 46 | | | |
| | 3.15.1 Buildings with User Committees Established | 46 | | | |
| | 3.15.2 Future Buildings | 46 | | | |
| | 3.16 Phasing Plan | 51 | | | |

1.0 EXECUTIVE SUMMARY

The University of Toronto acquired the Erindale Campus in 1965. Situated on the former Reginald Watkins estate on the bank of the Credit River, the Campus can be characterized by its bucolic setting. Two master plans influenced the early development of the UTM Campus. The original Master Plan, conceived by Raymond Moriyama, envisaged a single massive million square foot academic building at the south end of the campus, leaving as much as possible of the Campus in its natural state. A further Master Plan, devised by A.D. Margison, included plans for five residential blocks to the south of the main academic building, to be served by a Ring Road. Since 1972 the planning of the Campus has been essentially informal due to funding cutbacks. Although the aspirations of the original Master Plans to preserve the natural characteristics of the campus were admirable, the strategy of monolithic buildings resulted in an introversion and isolation of the culture of the campus. The New Master Plan aspires to connect the culture of the campus with the natural environment in a way that fosters connection, interaction and a vision for new educational possibilities at the University of Toronto at Mississauga (UTM).

Presently, the University of Toronto at Mississauga anticipates extensive growth due to demographics, rapid development of the Mississauga area, and the cancellation of grade 13. As the previous 1994 Master Plan could not anticipate this amount of growth the University of Toronto at Mississauga embarked on a process to define a new Master Plan. This Master Plan is the result of a process that would not only provide guidelines for future development but also, more importantly, define a new vision for the physical expression of the campus that would extend well beyond the foreseen growth.

Part of the new vision is the recognition that built form and open space contribute directly to the sense of community in a campus. Over the past few months, discussions within the Steering Committee and its sub-groups, have emphasized the importance of the campus as the centre of many people's lives and development. The landscape of the campus is a place of interaction and an essential connective element in the success of the University as a place of research and learning. The University of Mississauga, with careful and deliberate planning, can achieve an academic environment of distinction that is attuned to the natural features and characteristics of the Campus and builds on these strengths.

The new Master Plan strategically addresses the issues of growth, built form, microclimate, parking, ecology, culture, and circulation with an incremental and reciprocal implementation. As a result of the consultation and workshop process several key goals came forward as defining elements of the Master Plan: Image, Culture, and Environment. These goals transcend the utilitarian and expeditious necessities of any plan and act as guidelines that ensure the vision of the plan is sustained throughout the proposal.

Image

The public image of the UTM as an institution of distinction is essential to its continued success. The UTM Campus and setting is one of its strongest features and has unique opportunities for regional appeal. One of the principle goals of the Master Plan is to create a high quality learning environment that is conducive to intellectual quest and to active exchange of ideas. UTM's presence in the neighbourhood, and the value it adds to the surrounding neighbourhood, should be reasserted in the perimeter of the campus and the primary entries. The Master Plan proposes enhancing the appearance and identification of the University from the perimeter roads through the installation of unique elements and landscape features defining the Campus perimeter in a distinctive manner that is sensitive to the bucolic nature of the site. The approach to the main campus is an image that provides a lasting vision of the institution. The Master Plan has recommended entry plazas that define the entrance to the University as a civic space of social and cultural interaction.

Culture

The culture of a university is tied to its setting in an intimate way. The possibilities for casual interaction and a diverse lifestyle that mixes academic pursuits with athletic, cultural and recreational pursuits enhance the potential of the university. This increases the challenge for the Master Plan to provide a built environment that provides increased possibilities for this emerging culture.

One of the strengths of the present UTM campus is the compact form of its present buildings that allow the natural setting of the campus to remain. The compact form of these buildings conversely creates an introversion of its cultural relationship with the campus. The Master Plan proposes that future development is compact while integrating open spaces and pedestrian routes on a finer scale to create a vital, unified campus. A consolidated arrangement of

buildings that places related programs close to one another, while creating active exterior spaces would define an entwined, rich experience of passage through the campus. These open spaces would be designed with elements that offer both shelter and openness, areas for repose, and social interaction at many scales. These measures would enhance the sense of community within the Campus, for both, resident and commuter students, faculty and staff.

Environment

The environmental vision for the Master Plan is one that goes beyond preserving the picturesque qualities of the Campus and creates a plan that is truly integrated with the outdoor environment. These measures would involve adopting an adaptive management model for ecological performance in the sensitive areas identified. One of the essential aspects of the environmental model is that it recognizes the Campus' unique ecological and positive physical features, while enhancing the relationship and understanding of that environment. A trail system that provides access through but separation from the natural environment allows interaction without disturbing the natural process. Planted and paved open spaces of varying scale and character will offer space for individual contemplation and small and large gatherings while serving as well as orientation devices on the campus. The sensibility towards the majority of the landscaping could employ 'no-mow' strategies, allowing native plants and grasses to develop naturally. The campus should access and enforce its natural setting and the unique environment of the Credit River Valley. Stronger connections to the park system in Erindale Park should be encouraged.

Precedent - Gardens at Claremont, Surrey, England with amphitheatre.



1.1 Key elements of the Master Plan

The recommendations of the Master Plan include the following key elements:

Main Link

The Main Link is envisioned as a built structure that restores the original planning of the campus in a north-south direction. The link would connect the proposed buildings of the Master Plan while providing access to the adjacent open spaces. The Main link would be programmed with many public programs to increase its attraction to pedestrian activity and create a social space of interaction and involvement.

Five Minute Walk

The Five-Minute Walk would continue to be a major University route of pedestrian circulation on the Campus and it will be augmented with new routes. The walk would connect the east-west axis of the campus and have a more natural treatment as it passes through the woodlot area.

Courtyards

The proposed courtyards provide gardens and open spaces of varying scale and character that offer space for individual contemplation and small and large gatherings while serving as well as orientation devices on the Campus. Integrating the courtyards with the proposed built form not only maintains connection with the surrounding environment but provides views, sunlight, and better microclimate conditions for enhanced pedestrian comfort. These courtyards are passages that form the University's lifelines - arteries laden with opportunities to meet, sit, teach informally or merely traverse, that incorporate paved surfaces, seasonal gardens, treed areas, water features, even the buildings themselves thus blurring the line between indoor and outdoor space.

Entry Plazas

As much of the UTM population is commuter based the Entry Plazas become a significant site of social space within the campus. The proposed entry plazas incorporate bike lanes, drop-offs, seating, shelters and distinctive paving and planting schemes that enhance the experience of entering and leaving the university.

New Entrance

The entrance to the university provides the opportunity to define an image of the UTM as a unique and distinctive institution. The Master Plan emphasizes the importance of the presence of UTM in the community. The proposed new entrance and treatment of the university perimeter particularly along Mississauga road would retain its rural character while presenting the institution as a significant feature of the community.

Main Quad

The Main Quad is seen as the main recreational open space in the new Master Plan. The Quad is defined by the woodlot, the Main Link, the athletic centre, the theatre, the south building and the proposed residence. The built perimeter of the quad would be defined by transparency of vision and access and provide, porches arcades and other sheltering features. The quad becomes the focus of a range of activities including recreational sports, informal gatherings and performances.

Connected Residences

The present plan of UTM has left the residences significantly separated from the other activities on the campus. The Master Plan proposes that the new residences and the routes between be designed to foster a more connected relationship between the residential life and the academic life of UTM. The Master Plan has sited new residences closer to the center of the campus. The pedestrian routes have been designed to integrate with the proposed residence buildings to provide sheltered and active travel between buildings.

Integrated Built Form

The UTM Master Plan proposes to create a stronger sense of community through sensitive scaling and positioning of the new buildings. These new buildings offer opportunities to consolidate the Campus, enliven and shape the spaces between and within, while contributing to the creation of an entwined, rich experience of passage through the Campus that offers both shelter and exposure in areas for repose, and social interaction at many scales. In order to achieve such a relationship each building project is responsible for creating the open space that surrounds it. The vision of the Master Plan includes the acknowledgement that open space is the defining aspect of the building relationships. Consolidating the buildings and using them as linking devices will preserve more land for future development beyond the time frame of the proposed Master Plan.



Precedent - Courtyard space

Precedent - Misty Fountain at Harvard University by Peter Walker





Conceptual Image of UTM Square - Main Drop off and connection to Main Link

Coordinated Parking, Servicing and Traffic Plan

The success of the proposed Master Plan is dependent on a strong commitment by the university to integrate a coordinated parking, servicing and traffic plan with the more visionary proposals of the Master Plan. Without a strategy for underground and structured parking the higher aspirations of the plan would ultimately not succeed. The Master Plan identifies options for achieving the target parking figures as well as planting strategies for these large paved areas that respect practical issues such as land use, snow removal and capital cost. Efficient, multi-level lots have also been considered for key areas in close proximity to highly populated areas of the Campus. An unusual constraint for the university campus is the fact that it has only one road for access. Combined with its close proximity to a residential neighbourhood this presents a serious traffic issue that will have to be resolved through further study in relation to the Master Plan.

1.2 Implementation

The Master Plan is a result of a process of consultation the University began in January 2000 that included a steering committee, subgroups, an internal web site for student participation, consultation with municipal representatives, community consultation, and expert consultants from various fields. The consultation process was valuable not only in establishing principal goals and objectives for the Master Plan but also bringing forth the diverse opinions and issues that those primary goals would have to accommodate. The culmination of these ideas has resulted in a Master Plan with a strong vision and mandate that incorporates planned flexibility to accommodate diversity and change over time.

The Master Plan is not a capital plan. The urban design principles of the Master Plan will determine the shape of the new development as identified in the UTM's Capital Plan. By maintaining realistic goals with respect to resources, the Master Plan provides an implementation strategy that allows a healthy margin of flexibility in changing environments. Certain scenarios for development have been illustrated to demonstrate the intent of the Master Plan, but the actual programs remain flexible. At each phase the Campus is complete and improved with a more developed sense of community. In order for the Master Plan to be effective it is essential that the intent be followed in new building projects. The Master Plan document should be an integral part of any project brief that is dispersed internally and to professional consultants involved in UTM's future development.

The consultation process was an invaluable contribution for establishing the principle direction of the plan and owes a great deal to all the people and interest groups that provided input. The continuation of the collaborative vision relies on UTM's commitment to its implementation in each and every stage of development. To that end it is recommended that UTM assign responsibility for the Master Plan's implementation to one of its officers to ensure the continuity of the Master Plan process.

Precedent - Edge Condition - Main Drop Off Area / Pond Edge



2.0 BACKGROUND

Sterling Finlayson Architects was retained by the University of Toronto at Mississauga in January 2000 to revise the 1994 Campus Master Plan in order to direct future development for the next 10-20 years.

Anticipated growth due to demographics, rapid development of Mississauga and communities to the north and west, and the "double cohort" (that is a result of the cancellation of grade 13) will potentially see an enrollment increase of 2400-4900 FTE's representing 50-100% growth. New provincial government funding has become available through the "SuperBuild" capital fund for a new academic building, the Communication, Culture and Information Technology Building (CCIT). It is expected that additional government funding will be announced in the future, and that UTM will apply for additional funds for a new library and other academic facilities to support enrolment growth.

The existing Master Plan from 1994 did not anticipate enrolment growth and the development sites identified now accommodate the new residence and the New Student Centre as projected in the plan. New development sites must be investigated and proposed for additional residences, academic and non-academic buildings and take into consideration environmentally sensitive areas, landscaped open space, pedestrian routes, roads, parking and servicing. Then developments must provide an enhanced sense of community at the UTM.

The 2000 Master Plan provides guidelines for future development that identify development sites, proposed uses, open spaces which must be maintained, parking, traffic, servicing, connections, building / open space relationships, microclimate treatments, and landscape treatments. and phasing. Certain scenarios for development have been illustrated that demonstrate the intent of the Master Plan while allowing for flexibility in implementation and programme.



Aerial Photograph of UTM Campus and Immediate Context



UTM Grounds

1994 Master Plan Drawing

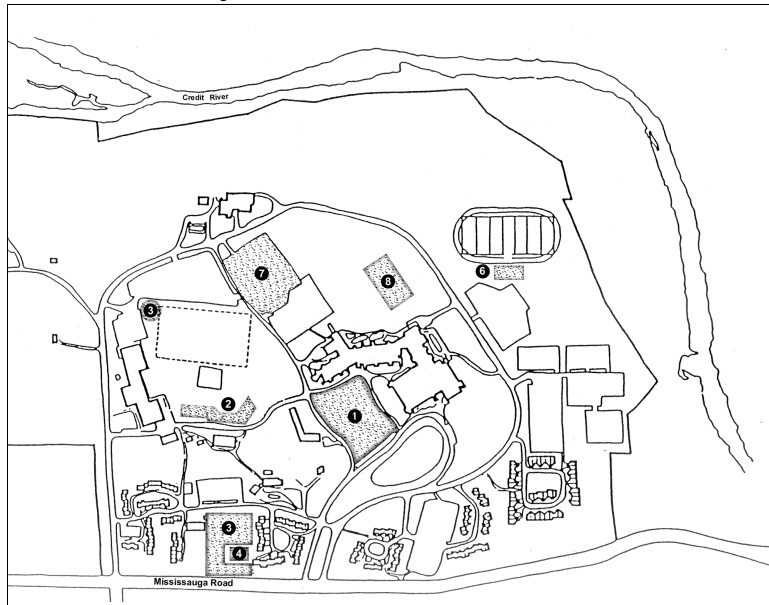

2.1 History

The Erindale Campus was acquired by the University of Toronto by a process of expropriation in 1965. It is located on the western bank of a bend in the Credit River north of Dundas Street, across from the historic village of Springfield/Erindale and just north of St. Peter's Anglican Church where Catherine Parr Trail remembered having tea with the Rev. James Magrath. The 224 acres consists chiefly of the Reginald Watkins estate (including Lislehurst, an historic mansion), a series of old excavated pits at the south end, (which we believe were clay quarries for bricks as a result of ponding in this area) and a number of residential properties along Mississauga Road.

Two Master Plans influenced the early development of the UTM Campus. The original Master Plan, conceived by Raymond Moriyama, envisaged a single massive million square foot academic building at the south end of the campus, providing a common home for all disciplines, leaving as much as possible of the Campus in its natural state. The South Building represents an early phase of this plan. A further Master Plan was devised by A.D. Margison, and included plans for five residential blocks to the south of the main academic building, to be served by a Ring Road. These plans were abandoned in 1972 when the government announced that the province's university system had excessive capacity and no further expansion would be funded.

Since then the planning of the Campus has been essentially ad hoc which, for most people, may have worked better than the monumentalism of the original concept. The buildings that have been constructed since the first phase of the South Building - the Theatre Building, Storage Sheds, Old Student Pub, Student Centre, and the Kaneff Centre - have resulted in the development of an east-west axis along the The Five Minute Walk, instead of a north-south axis, as conceived in both Master Plans. Faculty and students in the North Building are of isolation from the South Building where most of the UTM services are located.

Master Plan 2000 has endeavoured to identify realistic goals with respect to resources and municipal plans, a strong framework within which to work and an implementation strategy that allows a healthy margin of flexibility in view of changing environments. At each phase the Campus is complete and improves with a more developed sense of community as the phases are implemented.

2.2 Master Plan Issues

The issues and challenges of Master Plan 2000 were identified through a consultation process involving a Steering Committee and three sub committees and a process of public consultation. The Steering Committee was formed with broad representation from the University that included faculty, students and staff from business and support services and administration. Three sub Committees were established that represented groups with common interests - Academic Buildings, Non-Academic Buildings and Physical Resource Services. A series of workshops and a public meeting were held to identify the primary issues that would inform the recommendations of the Masterplan. The primary issues were as follows:

THE UTM - SENSE OF COMMUNITY

The appearance and identification of the University from the perimeter roads should be enhanced through the installation of unique elements and landscape features defining the Campus perimeter in a distinctive manner that is sensitive to the bucolic nature of the site. This would reinforce the larger community who would like to see the "rural" nature of Mississauga Road maintained. The new buildings offer opportunities to consolidate the campus and enliven and enrich the public space and sense of community.

CONSOLIDATION

Although the original "axis of College life" was planned in the north-south direction, it has evolved in the east-west direction along the "Five Minute Walk". The development along this route has been sporadic and faculty and students in the North Building complain that they are too isolated from the activities in the South Building. Dealing with this inherent polarity of the Campus, largely due to the desire to maintain the watershed area and the woodlot, is a key factor in determining the new development zones. Consolidating the buildings in these zones and using them as linking devices that fit into the framework of new Campus pedestrian route will offer a more compact solution and preserve more land for future development beyond the time frame of these Master Plan revisions.

PEDESTRIAN ROUTES

The Five Minute Walk should continue to be a major University route of pedestrian circulation on the Campus and it should be augmented with new routes. The new building program called for in the Master Plan offers the opportunity to consolidate the Campus and create a series of facilities that link the buildings together along pedestrian routes in a series of spaces that enclose, cover and direct.

ACCESSIBILITY

University buildings and pedestrian routes must be designed to be fully accessible. There were several concerns raised about some of the existing facilities. Future construction should ensure that barrier free routes are maintained.



Existing Open Space / Residual Space on UTM Campus



Existing Vehicular and Pedestrian Path System



Interior of the UTM Student Centre

South Building Congestion at Drop Off - UTM



TRAFFIC / VEHICULAR ACCESS AND CIRCULATION

In anticipation of future growth and the inevitability of increased vehicular traffic the committee reviewed traffic reports that were commissioned by the University that document the existing conditions. The UTM Campus has only one road, Mississauga Road, for access due to its location along a curve in the Credit River. This is very unusual for a university campus and is a serious constraint. The biggest challenge is to accommodate the increase in traffic flow and respond to the concerns of the community while adhering to the Site Plan Control By-laws and respecting the guidelines in the "Mississauga Road Scenic Route Study". The peak traffic times on Campus are 9:00am and 5:00pm. Much of the congestion within the Campus is due to the picking up and dropping off of students at these times. The existing Campus road configuration in the main drop off area (very narrow, little layby space) produces traffic jams where transit buses cannot pass through. The traffic jams present a more serious issue for emergency vehicle access to the South Building. Upon consultation with consultants and the public several issues surrounding traffic control arose:

- where the pressure points are when future traffic volumes are projected on the existing road system
- location and configuration of a new entrance to the University
- the capacity / configuration of the existing entrances- investigate any possibilities of improving operation the location of parking relative to the entry points which may be manipulated in order to reduce the volume of traffic on the internal road system.
- the lack of any left turn lanes at the North Entrance produces back-ups all the way to Burnamthorpe Road
- the turning radii are insufficient and the buses have to make awkward maneuvers to navigate the circuit.
- how to maintain the smaller scale and reduced speeds of the Ring Road system as well as the safety of the pedestrian realm
- there are very few sidewalks on the Campus, no bicycle lanes and safety concerns have been raised.

STUDENT AMENITIES AND FACILITIES

Many issues involving student amenities and facilities were identified throughout the Master Plan process. Some are operational, others involve new infrastructure. Many improvements can be accomplished with little expenditure. The importance of informal, exterior gathering spaces and play spaces was emphasized as essential to student life. One example given was Scarborough Campus, which has several fire pits and picnic areas that make excellent exterior gathering spaces. The committee felt that the campus should have more places for passive recreation, common study space and more after-hours services for those in evening classes. Lockers should be in lounge type spaces, not in corridors.

The current "Meeting Place" performs adequately for occupants of the South Building, but for no one else on Campus. It works because of its convenient location. It is traversed by some 20,000 people per day. This makes it very difficult for the new Student Centre to compete with the activity level, given its isolated location between the North and South Buildings. The Student Centre does not have enough active programming and the operating hours are not widely known nor well utilized.

PARK SYSTEM

Stronger connections to the park system in Erindale Park should be encouraged. The 18km long trail enters the campus at one of the parking lots beside the existing baseball diamond. It is used often by the children's programs and the environmental and leadership camps.

PARKING

As the expected growth projects an increase of the number of parking spaces with an increase in enrolment, parking issues will arise. If surface parking continues to be the main strategy the campus development will eventually be constrained by the sheer area of the surface lots. Large surface parking lots can be a formidable place both aesthetically and as a microclimate. The existing parking lots don't exhibit a sensitive approach to parking and pedestrian use. They lack a clear definition between pedestrian and vehicle paths, little or no shelter or planting to mitigate the expanse of the asphalt and they are not well integrated with the entrances and pedestrian routes of the campus.

SITE SERVICING

There is a major loading dock facility located in a sunken service court on the east side of the South Building which is accessed from the Ring Road. Specific local or smaller deliveries such as bar supplies and shop materials, are brought on an individual basis in routes off the Ring Road. In some instances service vehicles and delivery trucks have to come deep into the Campus precinct to make their deliveries. The grading of the site offers opportunities for locating the loading and service areas in a manner that screens these activities.

COMMUNITY CONCERNS

The main concerns of the City and the surrounding neighbourhood focus on possible traffic implications on Mississauga Road. Maintaining the low-rise residential character along Mississauga Road remains a key issue.

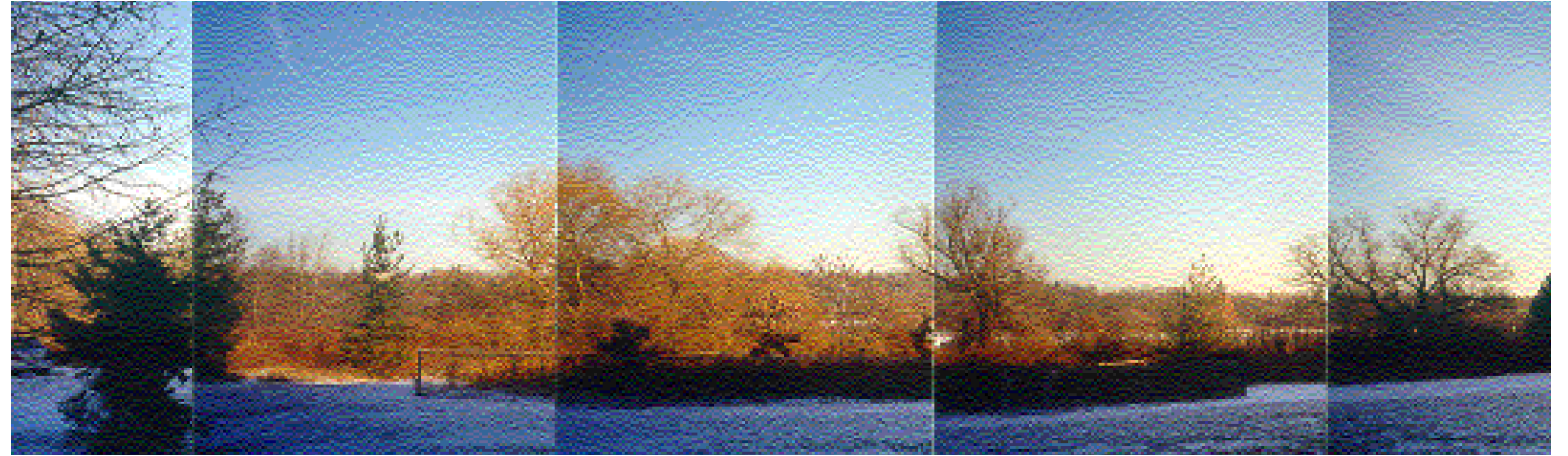

View to Credit River Valley from UTM South Building



UTM Parking Lot 6 in Residence Area



UTM Vision - Taken from "Kinnarps" advertisement

3.0 MASTER PLAN

The Master Plan is not a capital plan. The urban design principles set out will determine the shape of the new development identified in the UTM's Capital Plan. The development of this plan has entailed an examination of existing conditions on the UTM Campus, with a particular view to the selection and analysis of elements which can be reinforced to complement what already exists. The following vision for the Master Plan emerged from the consultation process:

3.1 Vision

IMAGE

The Master Plan aspires to create a high quality learning environment that is conducive to intellectual quest and to the active exchange of ideas. Such a plan should reinforce the public image of the UTM as an institution of distinction with unique opportunities for regional appeal by capitalizing on the picturesque qualities of the site and its features. The Master Plan aims to foster an academic environment of distinction that is attuned to the natural features and characteristics of the Campus and builds on these strengths. The image of the campus can be strengthened by reasserting UTM's presence in the neighbourhood and communicating the value it adds to the surrounding neighbourhood through access to campus grounds, programs and facilities.

CULTURE

The Master Plan proposes to enhance the UTM Sense of Community through sensitive scaling and positioning of the new structures and passages that form the University's lifelines. Arteries laden with opportunities to meet, sit, teach informally or merely traverse, that incorporate paved surfaces, seasonal gardens, treed areas, water features all contribute to a public space that encourages social and academic interaction. The proposed buildings can provide a continuous social space by blurring the line between indoor and outdoor space providing transparency to gardens and courtyards. These open spaces of varying scale and character offer space for individual contemplation and small and large gatherings while serving as landmarks on the Campus.

ENVIRONMENT

The unique ecological and positive physical features of the campus is one of UTM's strongest attributes. In order to preserve and build on this strength the Master Plan recommends creating a campus that is truly integrated with the outdoor environment and conveys a sense of spirituality and harmony. By adopting an adaptive management model for ecological performance in the sensitive areas of the campus and better microclimate conditions for enhanced pedestrian comfort, the campus would enhance the relationship and understanding of the environment.

3.2 Goals

- Consolidation - compacting the form of future development to create a vital, unified campus with a consolidated arrangement of buildings that places related programs close to one another, while creating active exterior spaces between them.
- Ecological Stewardship - adopt an adaptive management model for ecological performance in the identified ecological areas, that recognizes the Campus' unique ecological and positive physical features, while enhancing the relationship and understanding of that environment.
- Create a complex pattern of overlapping elements that together create an entwined, rich experience of passage through the campus that offers both shelter and openness in areas for repose, and social interaction at many scales.
- Provide planted and paved open spaces of varying scale and character will offer space for individual contemplation and small and large gatherings while serving as well as orientation devices on the campus.
- Locate Site facilities and circulation paths to allow for accessibility by the surrounding community, especially with regard to the Physical Activities Complex, Day Care, and facilities used by summer programs.
- Reposition parking, food services, library and other active programs to form a new cultural center of gravity that relates to the natural flow throughout the campus.
- Enhance the appearance and identification of the University from the perimeter roads through the installation of unique elements and landscape features defining the Campus perimeter in a distinctive manner that is sensitive to the bucolic nature of the site.
- Limit the vehicular impact on the surrounding community.

| | | Classrooms | Teaching Labs | Research Labs | Academic Dept Office Facilities | Central Admin Office Facilities | Library | Physical Education/Athletics | University Support and Services | Maintenance Shops | Total NASM |
|---|----------------------------|------------|---------------|---------------|---------------------------------|---------------------------------|----------|------------------------------|---------------------------------|-------------------|------------------|
| COU Generated Areas | At Existing Enrollment | 5,484 m2 | 3,817 m2 | 4,133 m2 | 4,773 m2 | 1,445 m2 | 6,782 m2 | 5,113 m2 | 9,140 m2 | 0,848 m2 | 41,535 m2 |
| Students | 4,570 | | | | | | | | | | |
| Staff | 314 | | | | | | | | | | |
| Total | 4,884 | | | | | | | | | | |
| Existing UTM Campus | As Built | 4,964 m2 | 5,915 m2 | 5,659 m2 | 5,352 m2 | 1,891 m2 | 4,206 m2 | 2,395 m2 | 8,398 m2 | 0,741 m2 | 39,522 m2 |
| Residences (Beds) | 850 | | | | | | | | | | |
| Beds Required at 22% | 1005 | | | | | | | | | | |
| Increase in Beds Required | 155 | | | | | | | | | | |
| City of Mississauga Parking Requirements | | | | | | | | | | | |
| 1.1 Parking Space per 100m2 GFA Institutional | 722 Parking Spaces | | | | | | | | | | |
| 0.15 Parking Space per Residence Bed | 128 Parking Spaces | | | | | | | | | | |
| Total Parking Required | 849 Parking Spaces | | | | | | | | | | |
| COU Generated Areas | | | | | | | | | | | |
| 50% Growth Model | | 8,159 | 5,651 m2 | 7,612 m2 | 8,420 m2 | 2,149 m2 | 8,591 m2 | 7,119 m2 | 13,598 m2 | 0,848 m2 | 62,150 m2 |
| Students | 6799 | | | | | | | | | | |
| Increase in Students | 1,915 | | | | | | | | | | |
| Staff | 479 | | | | | | | | | | |
| Total | 7,278 | | | | | | | | | | |
| Difference | 2,394 | 3,195 m2 | -0,264 m2 | 1,953 m2 | 3,068 m2 | 0,258 m2 | 4,385 m2 | 4,724 m2 | 5,200 m2 | 0,108 m2 | 22,627 m2 |
| Residences (Beds) @ 22% | 1496 | | | | | | | | | | |
| Increase in Beds | 646 | | | | | | | | | | |
| City of Mississauga Parking Requirements | | | | | | | | | | | |
| 1.1 Parking Space per 100m2 GFA Institutional | 1135 Parking Spaces | | | | | | | | | | |
| 0.15 Parking Space per Residence Bed | 224 Parking Spaces | | | | | | | | | | |
| Total Parking Required | 1359 Parking Spaces | | | | | | | | | | |
| COU Generated Areas | | | | | | | | | | | |
| 75% Growth Model | | 9,490 | 6,638 m2 | 8,077 m2 | 9,328 m2 | 2,500 m2 | 8,919 m2 | 7,118 m2 | 15,817 m2 | 0,848 m2 | 68,737 m2 |
| Students | 7909 | | | | | | | | | | |
| Increase in Students | 3,025 | | | | | | | | | | |
| Staff | 562 | | | | | | | | | | |
| Total | 8,470 | | | | | | | | | | |
| Difference | 3,586 | 4,526 m2 | 0,723 m2 | 2,418 m2 | 3,976 m2 | 0,609 m2 | 4,713 m2 | 4,723 m2 | 7,419 m2 | 0,108 m2 | 29,214 m2 |
| Residences (Beds) @ 22% | 1740 | | | | | | | | | | |
| Increase in Beds | 890 | | | | | | | | | | |
| City of Mississauga Parking Requirements | | | | | | | | | | | |
| 1.1 Parking Space per 100m2 GFA Institutional | 1255 Parking Spaces | | | | | | | | | | |
| 0.15 Parking Space per Residence Bed | 261 Parking Spaces | | | | | | | | | | |
| Total Parking Required | 1516 Parking Spaces | | | | | | | | | | |
| COU Generated Areas | | | | | | | | | | | |
| 100% Growth Model | | 10,822 m2 | 7,583 m2 | 8,998 m2 | 10,496 m2 | 2,851 m2 | 9,613 m2 | 8,116 m2 | 18,036 m2 | 0,848 m2 | 77,363 m2 |
| Students | 9,018 | | | | | | | | | | |
| Increase in Students | 4,448 | | | | | | | | | | |
| Staff | 644 | | | | | | | | | | |
| Total | 9,662 | | | | | | | | | | |
| Difference | 4,778 | 5,858 m2 | 1,668 m2 | 3,339 m2 | 5,144 m2 | 0,960 m2 | 5,406 m2 | 5,721 m2 | 9,638 m2 | 0,108 m2 | 37,841 m2 |
| Residences (Beds) @ 22% | 1984 | | | | | | | | | | |
| Increase in Beds | 1134 | | | | | | | | | | |
| City of Mississauga Parking Requirements | | | | | | | | | | | |
| 1.1 Parking Space per 100m2 GFA Institutional | 1413 Parking Spaces | | | | | | | | | | |
| 0.15 Parking Space per Residence Bed | 298 Parking Spaces | | | | | | | | | | |
| Total Parking Required | 1710 Parking Spaces | | | | | | | | | | |

3.3 Projected Growth

The adjacent growth chart, illustrates the projections for 50%, 75% and 100% growth scenarios based on COU standards. As certain components of the campus are currently below these standards, the amount of building to accommodate the 50% increase is considerably greater since there is a certain amount of "catch up" to do to bring the Campus up to the standards. These numbers are based on enrollment figures and usage targets for the academic facilities.

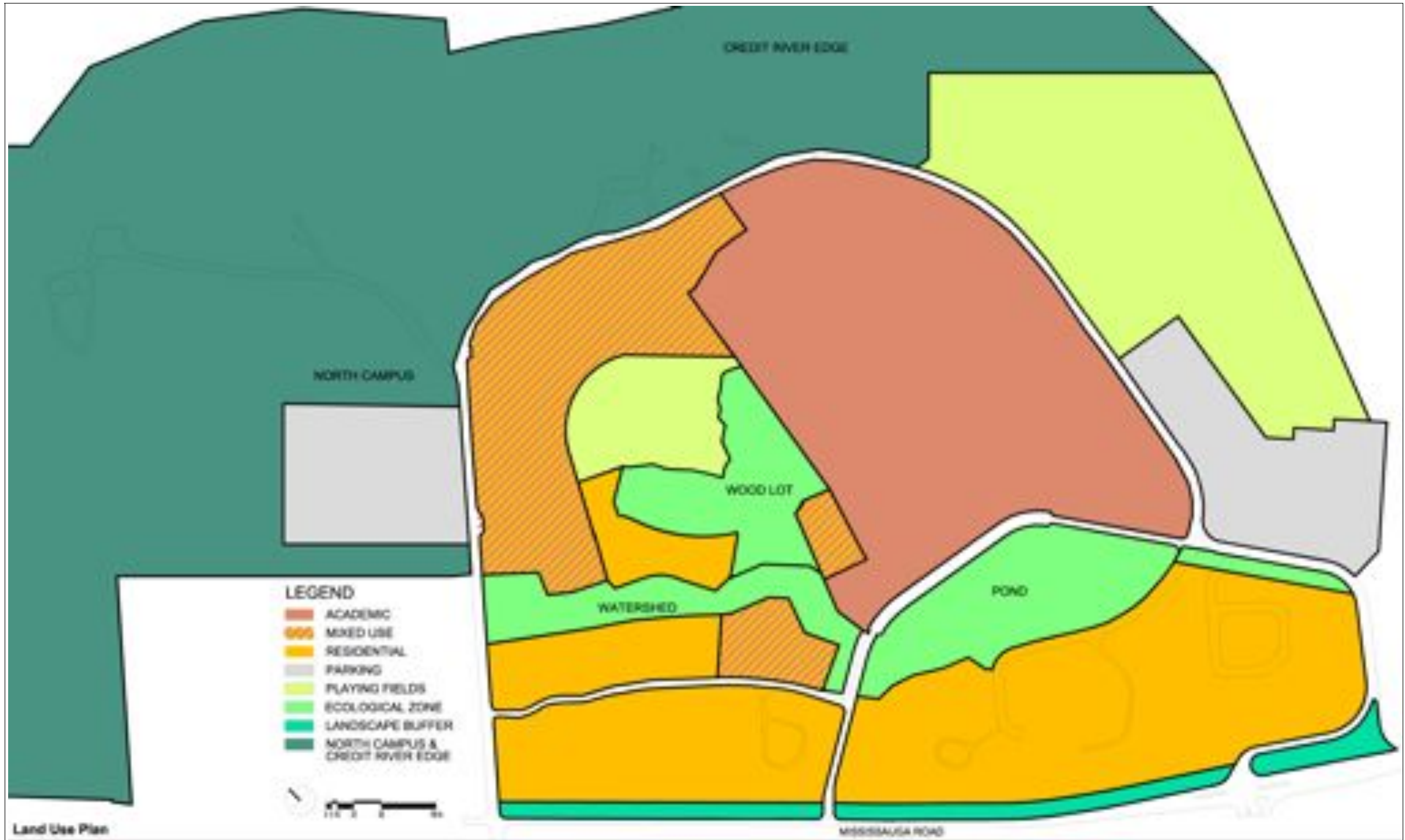

Land Use Plan

MISSISSAUGA ROAD

3.4 Land Use

The plan on the adjacent page shows seven categories of land use on the UTM Campus. Built form guidelines for these areas are described in section 3.6. All of the areas contain open spaces which are to be developed as integral components at the time of construction of each individual project.

These land use areas respond to the key objectives of the Master Plan that relate to consolidation while maintaining and enhancing the ecologically sensitive areas on the Campus.

ACADEMIC

The main area for the development of new academic buildings is consolidated north of the existing South Building. No new surface parking areas are allowed and underground parking is recommended where feasible.

MIXED

This term is used to allow a certain flexibility for the future planning of new buildings for the following uses: academic, physical education, day care, student residences, student and staff services. It is NOT intended that these areas would be used for surface parking or other utilitarian uses. Underground parking is allowed where feasible.

RESIDENTIAL

These areas are reserved for student residences and a small component of faculty housing. No new surface parking areas are allowed and underground parking is recommended where feasible.

PARKING

These areas can accommodate surface parking or structured parking.

PLAYING FIELDS

Field areas are for both Varsity and Intramural sports.

ECOLOGICAL ZONE

There are three parts of the ecological zone - the watershed (la5), wood lot (la4) and the pond (la6). All are "no-build", protected areas of the Campus. New buildings cannot encroach, bridge over or disturb these areas. In the watershed area only raised walkways such as boardwalks are to be used to cross these areas so that the vegetation and watershed is continuous. Surface paths in the wood lot are permitted, but they should be kept to a minimum number and width. Roads are not permitted within any of the ecological zones with the exception of the main UTM Drive.

LANDSCAPE BUFFER



The landscape buffer is also a "no-build" zone bordering Mississauga Road. It defines the precinct of the UTM with enhanced planting, seating, low walls and is punctuated by the new South Entrance.

NORTH CAMPUS

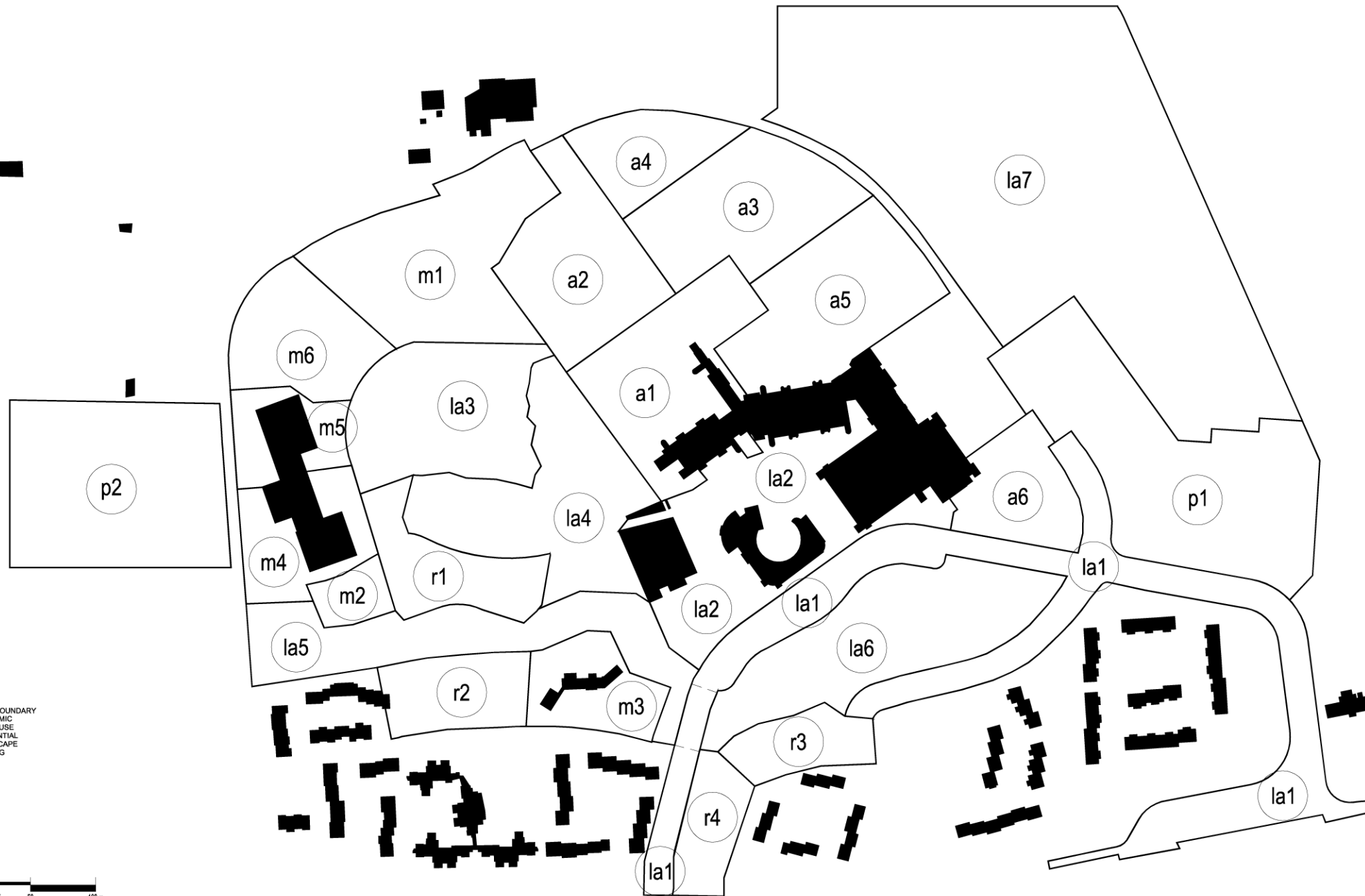
In an effort to consolidate the growth of the UTM, the North Campus was not considered for any development sites with the exception of a parking component. The south part of the Campus can accommodate growth well beyond the 100% growth scenario, so the North Campus has been reserved.



LEGEND

-  PARCEL BOUNDARY
-  a : ACADEMIC
-  m : MIXED USE
-  r : RESIDENTIAL
-  la : LANDSCAPE
-  p : PARKING

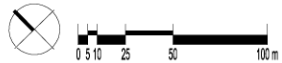

3.5 Parcel Plan

The Parcel Plan is a result of the intention to integrate built form with open space. The intention is to enliven and shape interior and exterior spaces, while creating a rich, entwined experience of passage through the Campus. In order to achieve such a relationship each building project must "take responsibility" for the development of the space around it. The Master Plan acknowledges that the open space is the defining aspect of the building relationships. By consolidating the buildings and using them as linking devices the parcel plan not only utilizes the land more efficiently, but at each phase, the Campus functions as complete and improved with a more developed sense of community.

The land use codes (**a,r,m,la,p**) of the Parcel Plan correspond to the Land Use drawing and the parcels reflect the full build-out scenario. The somewhat irregular shapes are a result of the natural features of the site and the inclusion of open spaces that are to be developed with each parcel. Combinations of adjacent parcels are possible to allow for flexibility of building footprint and program. Those parcels with an "a" prefix are in the academic building zone, those with an "r" are in the residential zone etc. The parcel categories are as follows:

ACADEMIC PARCELS (a)

The academic parcels are clustered in an area north of the South Building. They have been generated based on the following built form assumptions :

- low-rise buildings organized around courts
- an appropriate open space to building footprint relationship
- buildings would be connected by a series of interior and exterior routes

"MIXED USE" PARCELS (m)

The lines separating the "mixed use" parcels are flexible to allow for a variety of building sizes and shapes. The new buildings must maintain the setback to the road and they cannot project beyond the curved line bordering the west side of the UTM Quad.

RESIDENTIAL PARCELS (r)

The residential parcels are generally clustered near the existing residences, but they have been brought closer to the centre of the Campus. As with the "mixed use" parcels the lines separating the parcels are flexible, but each has been sized to accommodate a residence of approximately 200 beds at 4-5 stories and the associated open space requirement.

LANDSCAPE PARCELS (la)

The plan also include 7 parcels that are capital landscape / plaza / road work projects. Since these large areas are not attached to any specific building parcel, they will have to be independently funded.

Parcel **la1** represents a large undertaking that involves the creation of the new south entrance, the making of the UTM Drive and drop-off area as well as the reconfiguration of the middle entrance and the partial elimination of the road on the south side of the pond.

When developed, the Parcel **la2** project will accommodate the new UTM Square, Bus Shelter and rationalize the myriad of paths around the Kaneff Building, Student Centre and the South Building.

Parcel **la3** forms the open part of the UTM Quad. It is anticipated that the playing field will be used for intramural and informal pick-up sports as well as sitting and lounging areas.

Parcels **la4,5,6** are the three ecologically sensitive areas - the watershed, wood lot and pond. A large part of the work involved in realizing the projects in the ecologically sensitive areas could be undertaken by the UTM students and staff as the "living lab" is maintained and enhanced. As described in the Land Use section 3.5, these areas are strict "no-build" zones.

Parcel **la7** will be developed for a Varsity Sports program. With the anticipated growth, the outdoor sports facilities will have to be upgraded.

PARKING PARCELS (p)

Parcel **p1** represents the footprint of a three-level parking structure that would be required to fulfill the 100% growth scenario using the parking figures generated by the UTM. This is substantially more parking than is required by the site zoning.

Parcel **p2** is not fixed in its location. Rather, it represents the required footprint for surface parking required to replace Lot 6, part of Lot 3 and the new requirement as a result of growth in the 50% growth scenario (before any structured parking is constructed).

Landscape Plan and Bird's Eye View Perspectives



Comparison of Courtyard Styles in other UofT Buildings



New Innis Residence
772 m² Courtyard

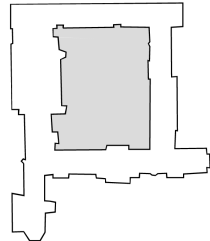

Trinity College
2406 m² Courtyard

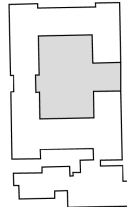

Other Residence
1163 m² Courtyard

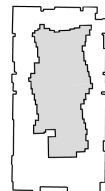

Massey College
1348 m² Courtyard

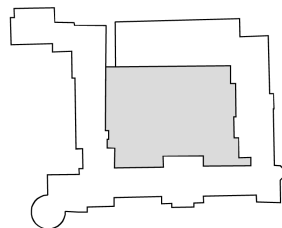

University College
2728 m² Courtyard

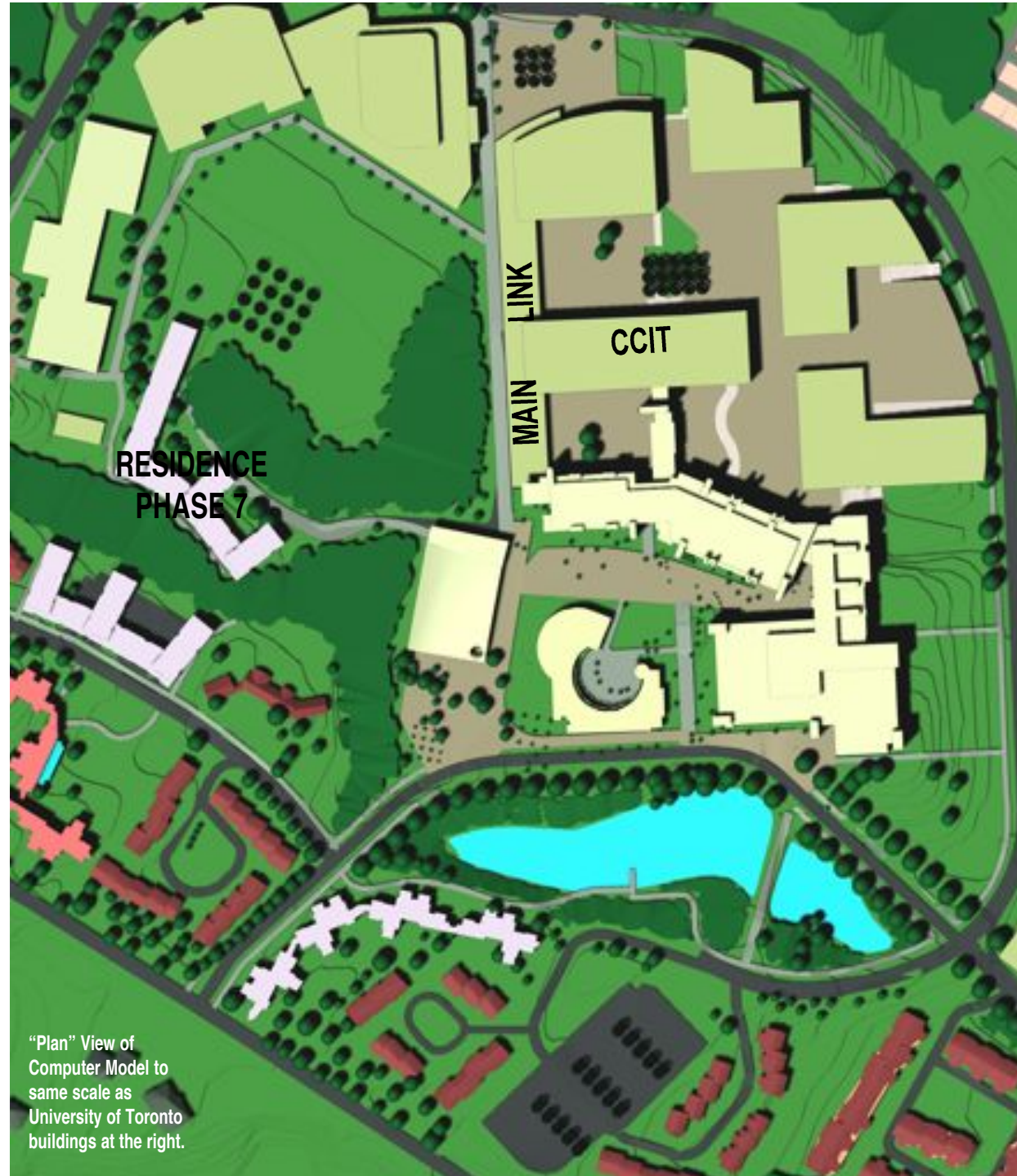

“Plan” View of Computer Model to same scale as University of Toronto buildings at the right.

3.6 New Building Envelopes and Design Principles

The built forms shown on the model and in the drawings are a demonstration of what the total build out might produce. In the short to medium term, this more dense form of development will not be achieved. Rather, a more open form of court will result between buildings - where the views to the landscape beyond are framed.

The building forms illustrated have been inflected to allow more sun access, views and to create courts of a scale that are more intimate and protected. Many of the issues to be dealt with in terms of built form relate to the creation of positive microclimate conditions.

Rather than providing a fixed architectural design for the total build out of the campus, the Master Plan concentrates on definition of potential development parcels at the macro scale and on provision of suggestions about specific detailed components of development and infrastructure improvements. The guidelines and illustrations for the parcels:

- Outline the systematic indoor and outdoor linkages vital to achieving the Master Plan goals;
- Identify open space requirements for each parcel;
- Provide heights, build-to lines and microclimate considerations;
- Propose performance criteria for the interface between these elements.

One of the key aspects of the phasing of development is that the Campus must appear complete at all stages rather than always appearing incomplete. The Master Plan phasing plans show the creation of an incremental, complex series of courts and open spaces, each building on the other, but complete at each stage.

The idea of the Link as an organizational structure is critical in this idea of phased development. Elements of the Link must be incorporated in the relevant, incremental building programs. The guidelines set out in the Master Plan document illustrate how each new structure has to accommodate more than its own immediate needs, and contribute to the larger Master Plan goals. Since it is unlikely that the buildings can be designed with a significantly lower efficiency level, priorities will have to be set in relation to the allocation of space in the building to ensure the continuity of the Link and the achievement of other goals. For instance, the CCIT Building is shown as an "L" shaped building. This in effect builds the first section of the Link and makes sure that this critical connection will be built as part of the initial construction. There is a danger that the Link may never be built if it is considered as a separate structure.



LEGEND

- PARCEL BOUNDARY
- a : ACADEMIC
- m : MIXED USE
- r : RESIDENTIAL
- la : LANDSCAPE
- p : PARKING
- BUILDING HEIGHTS +4 - +5 STOREYS
- BUILDING HEIGHTS +3 - +4 STOREYS
- BUILDING HEIGHTS +3 STOREYS
- BUILDING HEIGHTS +2 - +3 STOREYS
- BUILDING HEIGHTS +2 STOREYS
- BUILD TO LINES
- MICROCLIMATE CONSIDERATION

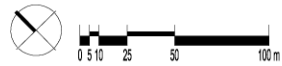

3.6.1 Heights, Build-to Lines, and Microclimate

The opposite figure illustrates a series of built form descriptors overlaid upon the general system of parcels described above.

The building height zones that are set out on the plan indicate general maximum heights for buildings and specific relationships between heights of portions of buildings within each parcel. In the parcels where building is anticipated in the early phases of the growth of the campus, more specific height relationships have been proposed in response to adjacent local conditions. In parcels where building is anticipated in later phases, less specific height regimes are suggested.

Taller building elements in the 4-5 storey range are anticipated in the more central areas of the campus with building heights gradually diminishing to 2-3 storeys as development proceeds outward from the centre. This allows buildings to respond to the surrounding built form context and the gradual slope of the topography to the east and the Credit river. It is expected that buildings in the outer ring of academic development such as a3, a4 and a5 could have building heights greater than 3 storeys at the ring road. Due to the slope of the ground in this area the buildings would maintain the 2-3 storey height adjacent to internal parcels such as a1 and a2.

In addition to building heights, a series of build-to lines are proposed. The build-to lines act in addition to the building height limitations to prescribe in plan where specific building elements are located. The build to lines represent areas where any proposed building MUST build a continuous face to the maximum height permitted on the parcel. This sort of mandatory building requirement is intended to establish specific relationships between building and landscape elements. Typically these build-to lines are located adjacent to the required contiguous landscape spaces specified in 3.6.2 below. These are intended to set the building scale and to establish continuity at the edges of these important open space elements. In addition, the build-to lines along the east and west edges of the main link building guarantee the connection of buildings built in different phases to one another.

Along with the heights and build to lines a third level of built form requirements is proposed. These are areas of microclimate control where building elements such as canopies and or wind shelves should be provided. These design features typically deflect down drafts of wind caused by vertical building elements that face in to the prevailing winds. The plan identifies areas where these features should be provided on new buildings as well as areas where they should be retro fitted on to existing buildings. The plan also identifies certain existing natural features that operate in a similar manner to these building features that should be maintained.

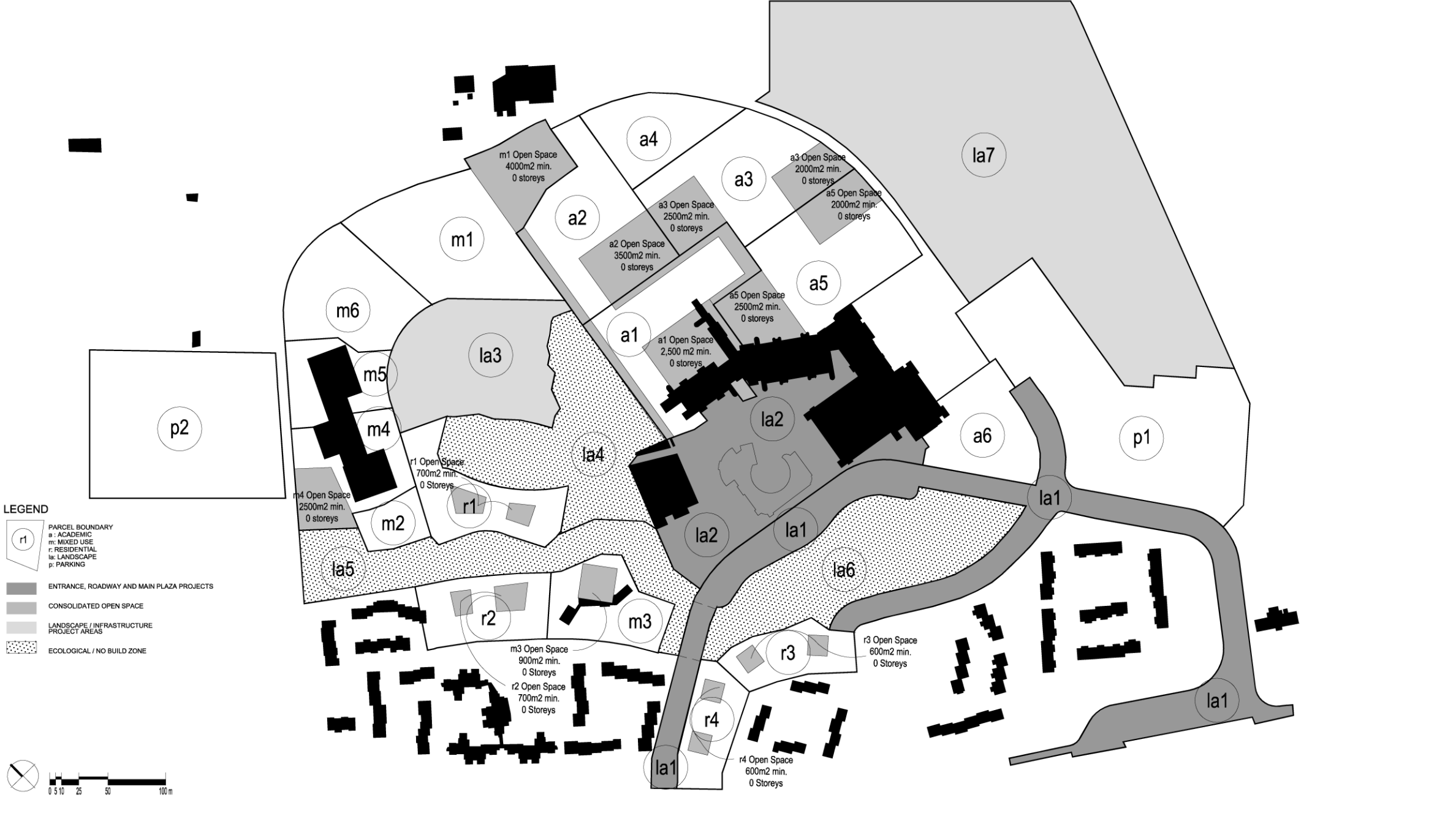

3.6.2 Landscaped Spaces

The opposite figure illustrates a system of specifically defined landscape spaces and ecological zones.

Each of the landscape elements that are not specifically related to a building parcel and all of the ecological zones have been identified with an individual parcel designation. Within the ecological zone there is a further distinction made between active and infrastructure related open space and the ecologically sensitive wetland area that runs through the centre of the campus (**la4, la5 and la6**).

The active and infrastructure related open spaces consist of the areas of improvement to the road system within the campus (la1), the campus entry and plaza improvements (la2) and the two large active recreation spaces (la3 in the west and la7 in the east). These are areas where separately funded capital projects are anticipated by the plan.

The required contiguous landscape elements that are associated with building parcels have been shown on the building parcels themselves. The minimum contiguous area of open space that should be provided on each parcel has been identified as well as an abstract representation of the potential shape of such spaces.

The size of these spaces relative to their individual parcels and the requirement for their connection to one another is the intention of this particular part of the plan. As outlined above, the shape of these open spaces should be read in conjunction with the Build to lines outlined in 3.6.1 above.

It is recognized that the shape and size of the specific parcels may change as the plan is built out. Beyond the specifics identified in the detailed parcel plans for the first buildings under the plan (3.6.4 and 3.6.5 below), these parcels and their open spaces are intended to provide a "context" for the design of the first building phase and for decision making on subsequent building phases.



3.6.3 Pedestrian Circulation

The opposite figure illustrates a network of proposed pedestrian linkages and paths overlaid upon the general system of parcels described above. Interior exterior hard surface pedestrian routes associated with individual buildings and parcels as well as a system of looser pedestrian paths have been separately identified.

The intention of this system is the reestablishment of the primary idea of the crossroads on the campus. This involves the proposition of the main link, a strong new north south pedestrian spine running from the open space to the south of the new Student Centre to the Ring Road. The main link is anchored at both ends by new hard-surfaced open spaces and the reinforced in the centre by its connection to the existing Five Minute Walk running in the east west direction.

At a secondary scale a system of exterior and interior pedestrian routes are proposed that provide clear, large-scale, highly visible connections through the campus as it develops. These include the connections running perpendicular to the main link through the academic building area (supporting the contiguous open spaces described in 3.6.2 above) and the path that describes the outer edge of parcel **1a7** the open space quad in the northern portion of the campus. This latter path makes a secondary connection between the new N-S spine and the western end of the Five Minute Walk.

Interior and exterior tertiary pedestrian routes provide a finer grain of circulation through the buildings and open spaces of the campus. These are generally located at the edges of buildings and open spaces where the maximum degree of pedestrian amenity and shelter from the elements can be found.

Pedestrian routes associated with new road construction have been considered by this plan. Please see section 3.12 below for detailed cross sections through proposed new roads for details.

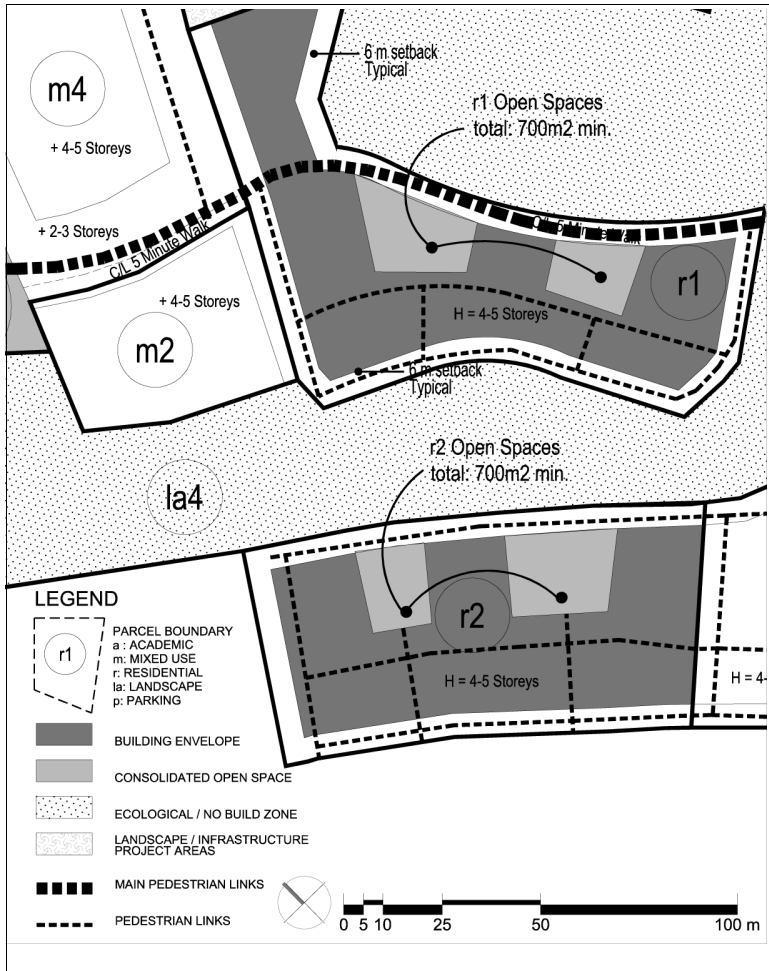

3.6.4 Residence Phases 7 & 8 Parcel Description

As there is considerable pressure to develop new student housing resources on the campus the plan has identified two sites for the next phase of residence buildings **r1** and **r2**. The sites for these new residences are located in close proximity to the existing neighbourhood of student residences. The proposed residences are anticipated to be a scale of building similar to that of the new Phase 6 residence building, however at a higher density relative to the parcel area and with some building elements that may be higher than the Phase 6 limit of 3 storeys.

The Master Plan clearly identifies the need to preserve the continuity of the ecological zone that runs between these two sites. No building elements should be proposed that cross this zone.

The parcel plans shown here indicate a general building footprint for potential building on the parcel, location and size of contiguous open spaces that would be required as well as the location of the pedestrian linkages at all scales on the site.

Parcel **r1** has been recommended as the first of these two parcels that should be developed as it offers the most potential to augment pedestrian activity along the Five Minute Walk and as it allows the continued use of Parking Lot x (the site of Parcel **r2**).

Development of Parcel **r1** requires the realignment of a portion of the Five Minute Walk in order to create a reasonable building depth and to make efficient use of the space currently occupied by the path. This realignment consists of a shift to the north-east so that the path itself is closer to the wood lot along its length. This involves the reconfiguration of a drainage swale and a small grass verge and can be accomplished in such a way as to increase the buffer between path and wood lot. Once this realignment is accomplished the site offers several unique building opportunities.

The illustrated building footprint shows a building that forms an "L" the longer leg of which is aligned with the edge of the ecological zone to the south west and with the shorter leg running perpendicularly to the north east, crossing over the Five Minute Walk. This crossing of the path establishes two important new dimensions to the Five Minute Walk area. It sets up an entrance to the campus from the west and it allows the residential neighbourhood to make contact with the open space at the west end of the campus.

The open space associated specifically with the residence itself will be located between the long leg of the "L" and the realigned Five Minute Walk. Pedestrian links should be located along the building faces. The ground floor of the building should be as transparent to view and pedestrian linkages as possible.

In order to create the 200 new residence beds that this phase of development anticipates, it is likely that some building elements in the 4-5 storey height range may be necessary. Careful consideration will have to be given to the location of such elements in order to minimize any potential shadow or wind impacts created on adjacent open space elements.

3.6.5 CCIT Parcel Description

Parcel **a1** has been identified as the site for the proposed CCIT building, an academic building that is intended to house a combination of Science, Computer Science and Humanities Programs. This building is to be the first new academic building constructed on the campus under the provincial government's Superbuild Growth Fund.

The specific form of building on Parcel a1 is critical to the establishment of a number of important aspects of the Master Plan. The CCIT building establishes the scale and configuration of both interior and exterior pedestrian connections along the north-south. The Main Link frames a system of connected open space courts that will characterise this portion of the campus and set up connections between the new academic buildings and the existing South Building.

The building footprint that is identified on this detailed parcel plan shows an "L" shaped space enclosing building. The footprint illustrates a main element that may reach a height of 5 storeys and a wing in the north south direction whose maximum height is set at 2 storeys to roughly match the height of the adjacent wood lot for the purposes of wind protection. Build-to lines as described in 3.6.1 above are shown in several locations on the a1 parcel. This indicates the high degree of specificity with regard to building location that is required in order to make this first step towards building the new campus.

For example, the two storey building component along the Main Link is required to be continuous to that height along its western face as well as at its ends. This represents the building form that will make it possible for the next phases of building to connect to the Link system.

It is important to note that the specific location of the southern end of this build-to requirement has to be determined by a more detailed design process. This first phase will establish the face of the new campus elements in relation to the west end of the existing South Building.

There is another specific build-to line shown on the west and north sides of the courtyard space. This indicates a requirement for a built edge to this space. The minimum area of the courtyard space is shown as is the requirement for a series of retrofit projects inside and adjacent to the existing South Building. The later components of the CCIT project will be necessary to control wind effects inside the new courtyard space and to promote more direct pedestrian links through the wing of the existing South Building.

A series of interior and exterior pedestrian linkages are indicated that range in scale and significance. The Main Link that runs from the open space to the south of the new Student Centre, to the Ring Road with connections through the existing South Building is the primary pedestrian route. It is supported by a series of smaller scale links through the proposed new building into the courtyard spaces. Additional pedestrian links should be located along the building faces. The ground floor of the building should be as transparent to view and pedestrian linkages as possible.

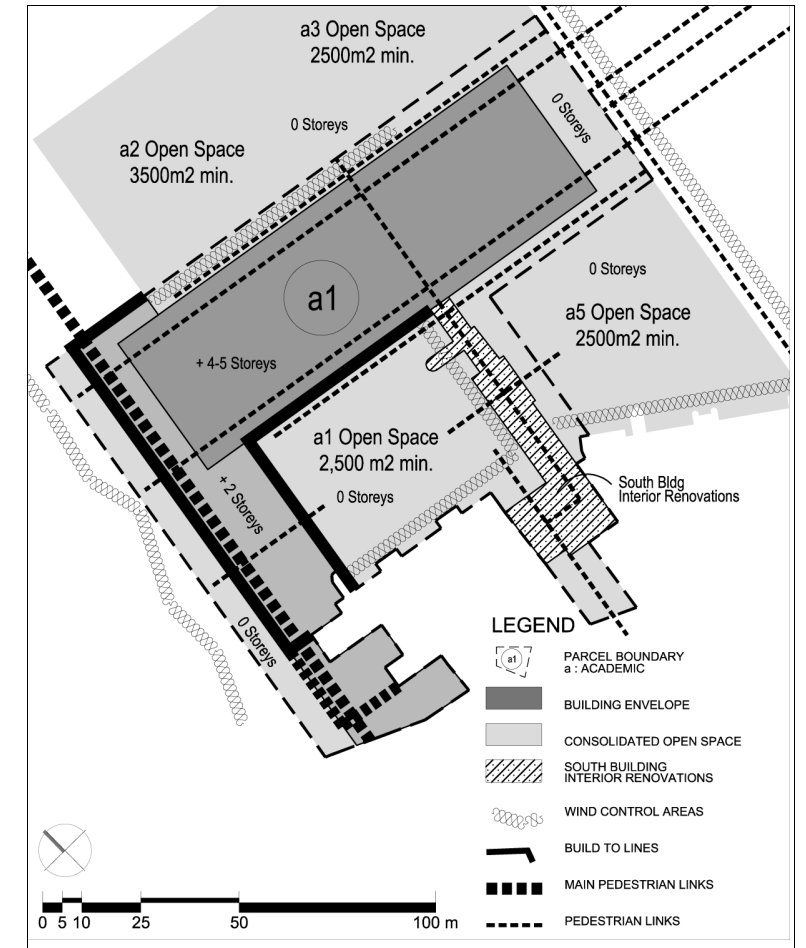

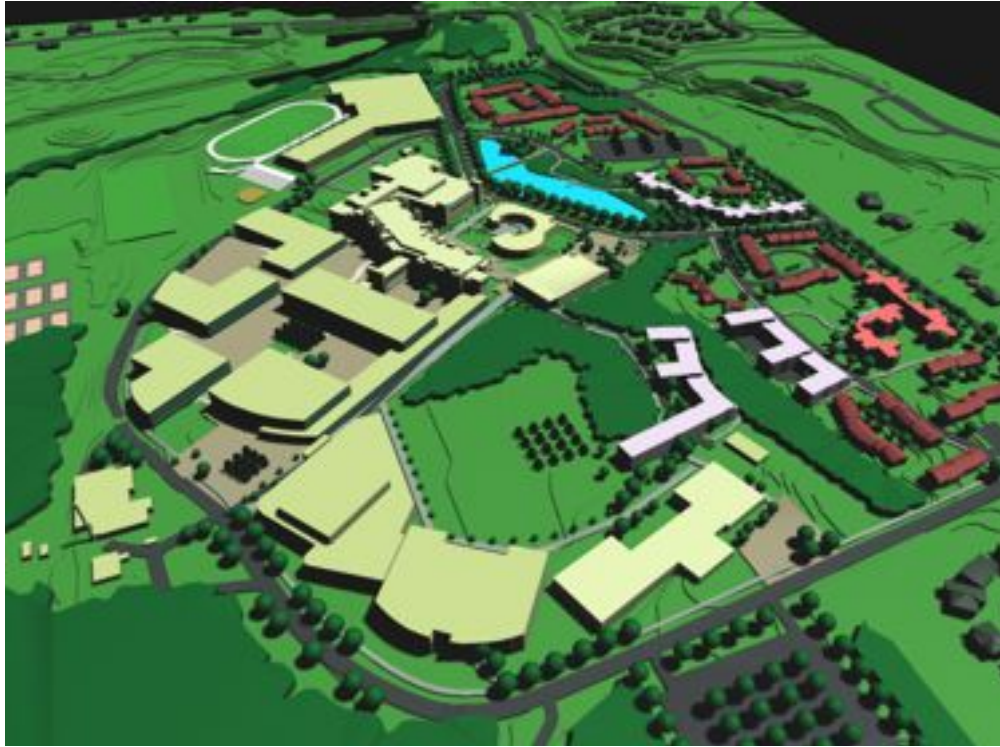

Computer Model View from the North

*Buildings Integrated into the Landscape
Precedent: Pavilion for an Exposition of Gardens, Weil am Rhein,
Germany by Zaha Hadid*

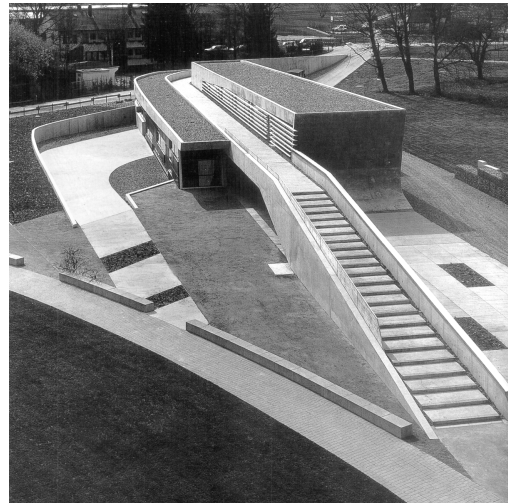

3.7 Built Form Issues

In principle the parking and the buildings should be consolidated and take up as little space as possible. The envelopes were developed through massing tests demonstrate the balance between the desire for consolidation and the desire to be connected to the outside. They will be buildings that enforce the sense of community and a relationship to the outdoors and will be sensitive to the ecological principles established for the Campus. The new buildings will develop the character of the Campus in a consistent fashion through consideration of factors such as building materials, building mass, relationship to open spaces, siting, circulation, views. The orientation of the buildings should optimize the access to sunlight in the courts - particularly in late fall, winter and early spring. The configurations should optimize the pedestrian microclimate conditions.

The general configuration is a composition of low rise buildings that terrace down the slope with opportunities for seeing over the tops to the ravine edge and on to roofs that are landscaped. Higher buildings may be appropriate for some uses - administrative and residential, but the lower rise solution creates more of a feeling of community in an academic setting.

Classrooms and high-volume uses should be confined to the lower levels so that stairs can still be used for the main circulation since it is expensive to plan for enough elevators to handle the peak loads. Administrative functions could be located on the upper levels, thus zoning the buildings vertically. This may be appropriate for some building blocks, but care must be taken not to create an inflexible arrangement. Over time the use of some buildings may change and limitations may come to bear on alternative arrangements of the academic facilities within (i.e. relying on the elevators for moving large volumes of students).

Many of the new spaces do not require natural light, and these could be accommodated in the lower levels of buildings that are set into the hill. In some cases it may be possible to have two stories of space partially underground so that the apparent height is reduced.

On the east side of the UTM Quad, a glazed Link connects the new buildings and operates as a single-loaded "Mall" to provide views to the woodlot and Quad, frontage for student and staff services and to enliven the passage through the Campus. Parts of the new buildings will contribute to this indoor link. The location of the link and the corridors within the proposed buildings have taken into consideration the main pedestrian traffic patterns from the South Building and the large lecture hall in the Kaneff Building. A paved area adjacent to the Link provides access for emergency vehicles and outdoor pedestrian path. The woodlot would abut this paved surface offering dramatic contrast in a similar fashion to the paved area bordering the pond.

Building Materials

Consistency of the Campus building materials will also help to create a more coherent Campus. The current pattern is that the residences have brick cladding and the other buildings are clad in a variety of materials all in light tones. A natural palette of materials complementary to the Credit Valley stone was seen as the right direction. This stone has quite a range of colours - from various shades of grey to deep ochre. There are many other materials that would work with this palette and be complementary to the existing structures. The Principal's Residence is made with this stone.



*UTM Main Link - Transparency to Courtyards, Woodlot, Quad
Precedent: Het Valkhov Museum, Nijmegen, Holland by Ben van Berkel*

*UTM Main Link - Transparency to Courtyards, Woodlot, Quad
Precedent: Het Valkhov Museum, Nijmegen, Holland by Ben van Berkel*





Precedent - Waterfall between two Pond Areas



Autumn Maple and Beech Forest

3.8 Ecological Principles

Two ecological assessments were done of the watershed and woodlot areas. One was by Dr. Stephen Murphy, an independent consultant and the other was by UTM staff. Both reports are in the appendix. In summary, they both recommended that the watershed and woodlot areas not only be retained, but that they be restored. The recommendations for ecological restoration include retaining the central wood lot and the watershed as an ecological zone. This would serve as a major element in the centre of the campus. Having an ecological treed zone in the campus center would allow the Master Plan to capitalize on buildings' relationship to that zone.

To ensure that the ecological zones remain a desirable amenity in the campus it would be essential to restrict any new buildings from encroaching in the ecological areas. The areas would be "no build zones" with the exception of boardwalks and trails designed so that drainage, plant development and wildlife movement will be disturbed as little as possible. The ecological zones would have evaluations of existing natural features and mature trees and if their value justifies their existence, they will be protected. Policies ensuring that the sensibility towards the majority of the landscaping employs 'no-mow' strategies, allowing native plants and grasses to develop naturally. These strategies reinforce the natural setting of the campus and the unique environment of the Credit River Valley.

ECOLOGICAL APPROACH

The UTM should take an active role in promoting the conservation techniques required to maintain an adaptive management approach the "outdoor living lab". Students could be involved as part of an educational effort, and could provide much of the restoration labour.

To further maximize the effect of the regeneration, the portion of main drop-off road between the northwest residences and the pond could become more of a bridge with the incorporation of a large culvert section that would allow the watershed to continue under the road in an uninterrupted fashion. The knoll at the north end of the wetland, the wetland and the pond must be strengthened as a unifying element. These lands will have to be protected with a firm hoarding during the construction of the proposed new residences.

By extending the pond to the southeast a dynamic element is introduced into the landscape that reinforces the grade changes on the Campus and marks the ceremonial entry into the Campus. The extension towards the Credit River can continue with planting to reintegrate the

ecological zone back to the river valley and close the ecological loop. The edges of the pond area must be integrated into the immediate surroundings to anchor the pond as a part of the Campus. Delineating the edge with mown grass simply serves to isolate the pond. The woodlot should be retained and strengthened. It is fundamental to incorporate the quad into the larger green space system, and if not considered carefully the woodlot could serve to sever it.

3.9 Landscape Goals

The goal in the approach to the landscape is primarily to develop a sense of place for the Campus. The Master Plan provides a strategy for implementation that is flexible, realistic and establishes an identity for the Campus. By allowing the ecological zones to complement the Campus structure, these areas are strengthened, have a larger meaning on the Campus and integrate the Campus with the surrounding Credit River valley. A clear balance must be established between the pedestrian and vehicular traffic on the Campus.

Strong open space planning is necessary to plan a successful and vibrant Campus. Clearly establishing a green infrastructure can make this a reality on the Campus. As a powerful form-giving and humanizing device, plants can visually structure the Campus. With proper positioning plants can create shade in the heat of summer and protection from winds in the winter. Plants introduce colour and seasonal variation to the Campus, and they have the capacity to improve the quality of our health and to beautify our surroundings.

PLANTING STRATEGIES:

In all planting strategies thought towards year-round appeal in the selection and placement of plant material will only improve the outdoor experience. Underlying the process is the belief that the ultimate aim of any planting design is not simply its aesthetic affect, but also plant health and education. Plants will provide orientation on the Campus, and they will be configured to provide create spaces and sequences of spaces throughout the Campus. Plants will be selected to enhance all seasons.

Ecological zones:

The planting strategy in the ecological zones will be a continued regeneration program, expanding the restoration to their natural condition wherever possible to increase the natural ecosystems. The goals of this approach are to

- Reestablish biological diversity and integrity
- Enhance wildlife habitats
- Protect and enhance environmentally significant area
- Establish and strengthen existing linkages to the valley lands from the Campus
- Diversify conditions along trails
- Address existing and potential erosion problems
- Control spread of invasive species
- Promote community stewardship

Plant species proposed in the ecological zones will be native plant species mixes that are designed for the specific site conditions such as southeast-facing slopes etc. The proposed mixes should allow for a variety of activities from flowering plants to wildlife. Protection of environmentally sensitive areas can occur through the use of naturalization to buffer and restrictions on land used for high activity areas.

Ecological restoration and a return to healthy natural environments is an initiative that will dominate outdoor space design in this century. Site restoration has both local and regional dimensions. Locally it is about restoring derelict or stripped land and regionally it is connected to the role of people in returning places to a level of ecological functioning. The Campus location on the Credit River Valley provides a direct connection to a significant regional resource. Exploring the possibilities of regional plants and plant communities not only improves the chances for plant health, but also works towards promoting regionalism which recognizes and enhances the characteristics of a given area.

Any circulation through the ecologically sensitive areas must occur either on raised walkways that completely separate the pedestrian from the ecosystem or through the use of paths that are wide enough to accommodate people and should encourage people to stay on the paths.

Central Campus and Residential Areas:

The central Campus planting strategy will consist of a mixture of native and introduced species. Introduced species will have to carefully considered to ensure they are slower growing and non-invasive. The general strategy of reducing areas of mowing to a minimum will be adopted leaving turf primarily in areas of playing fields. Substituting turf with the planting of ground cover and other low planting in higher use and circulation areas must be adopted.

Since the control of invasive, non-native plants in parkland is a growing concern, particularly with the adjacency to the valley ecological areas, the plant selection for the main Campus areas should be carefully considered to avoid planting any invasive introduced species of plant material such as Norway Maples etc. Fragmentation of habitats accelerates invasive species introduction and makes plant communities more susceptible to invasion. This is an issue to be addressed since the heart of the Campus is composed of fragmented habitats.

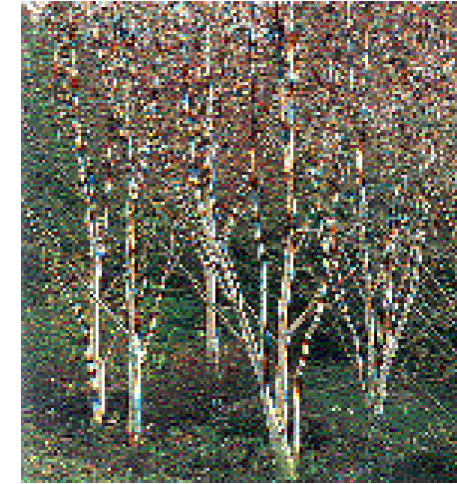

Precedent - Birch Grouping



Precedent - Major / Minor Path networks



University of Toronto at Mississauga Student Centre by Kohn Shnier
Blurring the boundaries between inside and outside space.

Accessibility Integral in Landscape.
Precedent: Unitat Gardens, Barcelona by Cubiertas y Mzov

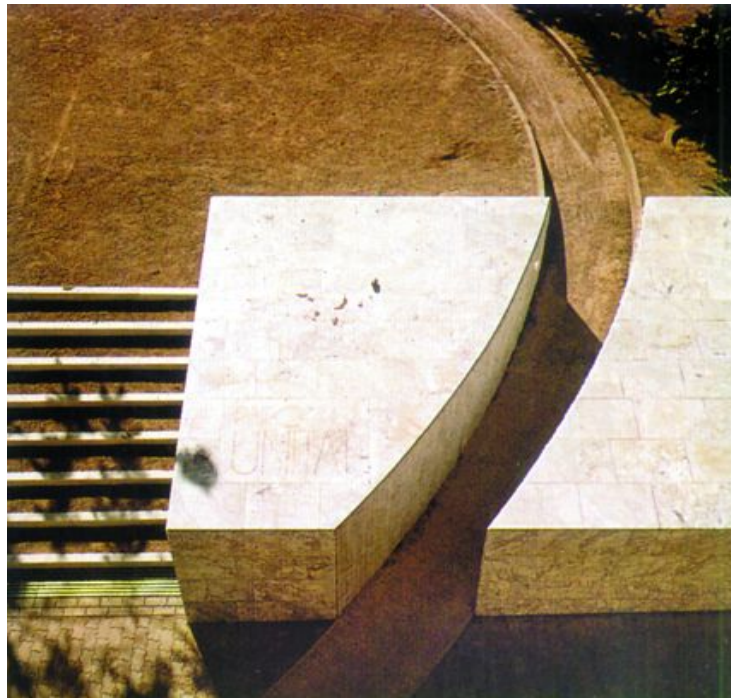

Creating a distinctive and meaningful open space using simple detailing and change in elevation with sensitive planting design.

Precedent: Unitat Gardens, Barcelona by Cubiertas y Mzov



MANAGEMENT / MAINTENANCE STRATEGIES:

Traditional

Active use areas such as sports fields, parking lots, primary circulation areas in the heart of the Campus and transition areas require a traditional maintenance program to accommodate the heavy demand placed on these areas.

Preserve / Protect

Vegetation communities that should be preserved are those that represent regionally unique plant assemblages, contain rare or endangered species, provide diverse habitats for wildlife or provide an aesthetic focal point. The existing landscape character is managed through simple controls such as restricting pedestrian traffic.

Natural Regeneration

Under this approach, the existing landscape character is changed by allowing natural regeneration to occur. For example, in turf areas, the mowing program is suspended, allowing the site to revert to a more natural state for pioneer species to colonize the area. This management program is appropriate in situations where there are favorable site conditions for self-seeding by native species and time is not a consideration in achieving the overall management of the site.

Irrigation

In areas of natural regeneration irrigation will be necessary for the first year following seeding and/or transplanting. In areas of traditional management a full irrigation system is necessary to ensure growth, a desirable appearance and to minimize maintenance and plant replacement.

STANDARDS FOR SITE FURNITURE AND LIGHTING

A vocabulary of planters, walls and seating must be developed for the Campus. The approach is to create a system that functions at the larger scale of the Campus and acts as a unifying element. Rather than select pieces of furniture to address one-time requirements, a more cohesive approach must be adopted. The vocabulary will consist of a series of walls taking inspiration from the natural sculpted landscape throughout the Campus which will define spaces, be multi-functional and sculptural. The walls will provide the structure and support for seating benches, lighting and trellises as required.

This multi-functional approach will strengthen the scale of the Campus, it will reduce maintenance costs and define spaces along the path system.

LANDSCAPE MATERIALS

The materials selected for the landscape must enhance and reinforce the material selection on the proposed buildings. Pre-cast unit pavers are the usual least-expensive choice for paving. For cost considerations, in areas where concrete pavers are necessary they should be balanced with a more defining material such as concrete banding. In areas directly adjacent to buildings co-ordination of materials with the architecture is fundamental.

Along walkways where snow clearing may prevent the use of stone or concrete pavers concrete banding can also be used to unify the path and provide alternate textures.



Precedent - Wall / Seats to negotiate grade changes

Precedent - Paving Pattern and Material Mix
Layet-Confient-Pestana - Valldaura Axic, Barcelona by Agroman Comylsa, Traco



3.10 Open Spaces

Open space and landscape priorities

UTM campus has the potential for becoming a distinct campus in the region. Its location, natural features and topography combine to set the stage for a campus that integrates its open spaces to create new possibilities for an academic community. Some of important steps toward a remarkable campus are to:

- Connect central Campus to ecological zones in a way that reinforce one another.
- Develop clear circulation system with a hierarchy of roads and paths.
- Develop open spaces that relate to the existing buildings and create a sequence of movement.
- Integrate ecological zones so that they do not act as isolated entities.
- Relate playing fields to their edges and give definition to the spaces.
- A central unifying open space is needed as a unifying element on Campus with a series of smaller outdoor spaces along major pedestrian routes. The proposed quad creates an opportunity to reconnect significant outdoor space into Campus community
- Microclimatic considerations are significant since the site is very exposed, and primarily used during the most extreme seasons

UTM Quad

A major green quad (the UTM Quad) is proposed that will use the existing west playing field for informal sports activities. It links the two sides of the Campus in a circuit defined by the Main Link, the Physical Education arcade, Theatre Complex, North Building, Residences and the Five Minute Walk.

The UTM Quad is seen a highly active space that links many of the activities at the UTM. The complete circuit provides access from two directions and creates a situation where no building is "at the end" and thus perceived as remote. The proposed Physical Education building provides a natural connection to the playing fields. The after-hours function of the Physical Education Building, Library, Theatre and the residences provides a level of security and passive patrol. The creep of the treed zone into the quad provides an interesting overlap and brings the more spiritual centre of the Campus into the Quad. Activities in the quad would include informal and intramural sports such as pick-up football, frisbee, volleyball etc. The UTM Quad could also incorporate smaller spaces for informal gatherings or reading and a dining facility and/or barbeque pits.

Courtyards

The creation of a series of courtyards that improve microclimate conditions and provide distinction, order and address for the new buildings. It is important, not only to make good buildings, but to make an architecture of the spaces between the buildings.

The creation of a large single paved figure to gather together the residual spaces between the South Building and the Kaneff Building, as well as the random paths that traverse the area, redefines this space as a court. The areas bordering the paved figure would be landscaped spaces designed to improve microclimate conditions for casual seating etc.

SAFETY / SECURITY

The "Toronto Safer City Guidelines" published by the City of Toronto Community Services should continue to be representative of the safety and security measures incorporated on the UTM Campus. The Main Link and the arcade-like corridors built into the ground levels of the new buildings offer a safe, well-lit space to traverse the Campus. The design of open spaces should avoid dead end conditions. Having the residences, the Physical Education Building, and the Library (all which have after hours activity) adjacent to the new quad creates a certain level of security through passive patrol thus providing safer passage throughout the Campus. The wooded area in the quad was not seen as a problem as long as proper lighting was incorporated.

- By developing a hierarchy of circulation we can provide pathways that are used more often by more students and consequently safer routes
- All primary circulation routes and walkways to parking areas must be well-lit, as well as areas that are hidden and removed from direct views.
- Emergency telephones or panic buttons are required throughout the Campus at regular intervals
- In the planting strategy, views should be kept as open as possible. In areas where shrub planting is required, planting should occur 3m-5m away from the edge of the walkway or road.
- Shrub planting should be minimized throughout the Campus
- Well-defined and visible pick-up areas should be provided in two or three key locations.
- A safety audit be conducted on a regular basis throughout the Campus

Precedent - Boardwalk path that protects and allows watershed



3.11 Microclimate

Microclimatic conditions on the Campus can significantly alter the experience for the students on the Campus. Existing tree planting should be retained as much as possible throughout the Campus. Supplementing this with a continuous understorey planting will decrease the adverse affects of wind on the site. This approach must be co-ordinated with the planting strategy and the issues of safety on the Campus. In the existing woodlot understorey planting can be strengthened in the interior of the woodlot. For safety considerations the understorey planting should not be extended to the edges of the woodlot.

In areas of proposed buildings planting strategies must be employed to decrease the affects of wind, particularly in the areas of courtyards. These strategies will also alleviate the accumulation of snow-drifts throughout the Campus. It is suggested that wind studies be undertaken whenever new construction is proposed on the Campus to ensure detrimental microclimatic conditions are controlled or eliminated.

The aim of the microclimate design guidelines is to provide planning concept guidelines to assist with designing building masses that will:

- consider the exposure to wind and drifting snow to improve the localized climate within the development area; and,
- increase the amount of time that outdoor areas will be comfortable for pedestrians during the fall/winter/spring seasons by promoting the use of wind screening to encourage light to moderate winds to flow through the area.

The study conducted for the Master Plan involves a review of the anticipated pedestrian wind, and snow drifting conditions and investigates the following:

Pedestrian Wind

- orientation and general massing of the development with respect to the primary wind directions;
- location and shape of specific design features that could induce wind activity; and
- methods to resolve wind problems.

Snow drifting

- orientation and general massing of the development with respect to the primary wind directions associated with drifting snow;

- location and shape of specific design features that could induce snow drifting; and
- methods to resolve snow drifting problems.

The current review is based on:

- a review of local meteorological data;
- a site visit and project workshop conducted on April 11, 2000;
- experience with other similar projects; and,
- RWDI's best engineering judgement.

The terrain surrounding the site is generally flat and is predominantly covered with trees, especially to the west. The southern edge of the site is largely residential, with many mature trees. The campus has a significant number of coniferous trees. The primary time for the use of this campus will be during the fall/winter/spring (ie., September through to April).

Recommendations have been made that combine meteorological data and site conditions with future design features that will improve the local microclimate.

Meteorological Data

Long term weather data gathered at L.B. Pearson International Airport were analysed to determine the prevailing wind directions at the site. The results of this analysis are shown in Figures 2 to 8.

When considering all winds (Figure 2), the most frequent summer winds occur from the west, north-northwest and north directions, with secondary winds from the southeast quadrant. The stronger winds, which occur on average once per month, originate from the west-northwest (20%) and west (24%) and to a lesser extent the west-southwest, southwest and northwest (Figure 3). In the winter, (Figure 4) the west, north, west-southwest and north-northwest winds are the most prevalent winds with secondary winds from the southwest, west-northwest and northwest. The stronger winds occur from the west-southwest (19%), southwest (12%) and west (22%) (Figure 5).

Based on the above analysis, for the purposes of the current qualitative pedestrian level wind assessment the following wind directions will be considered prevalent:

- southwest;
- west;
- northwest; and
- north.

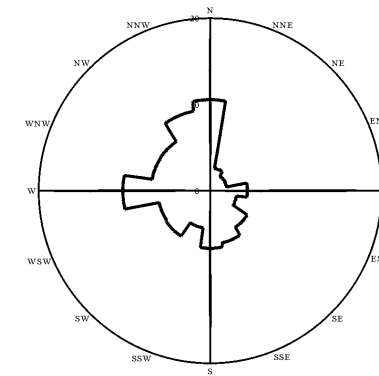

Figure 2
All Summer (May - Oct.) Winds

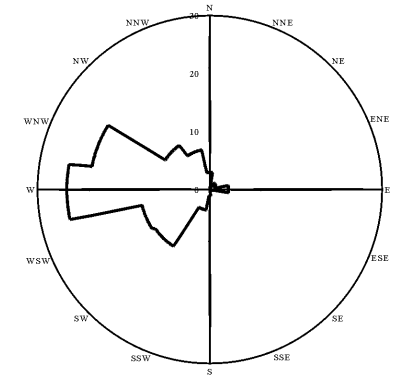

Figure 3
Summer Winds > 40 km/h

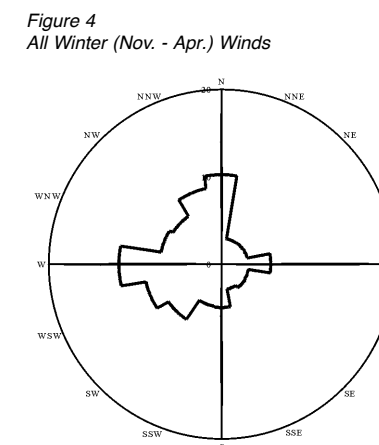

Figure 4
All Winter (Nov. - Apr.) Winds

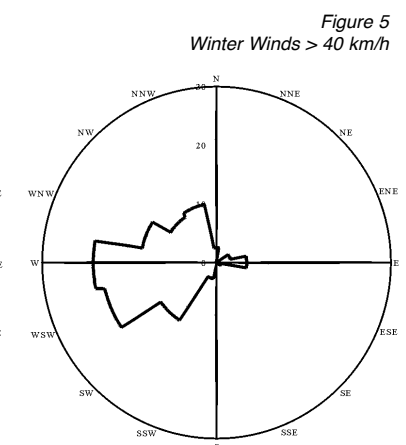

Figure 5
Winter Winds > 40 km/h

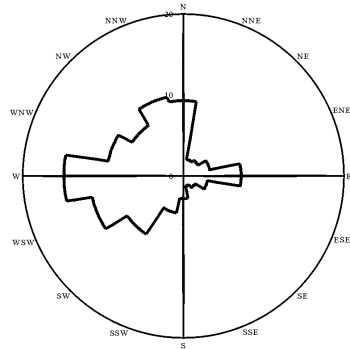

Figure 6
Winter Winds > 15 km/h

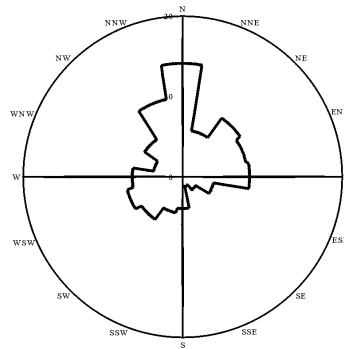
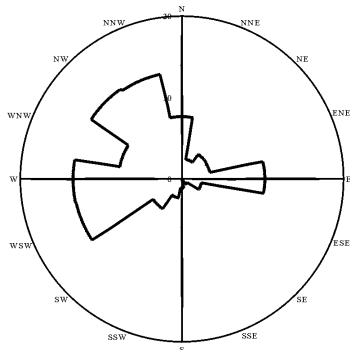

Figure 7
Winter Winds > 15 km/h with snowfall

Figure 8
Blowing Snow Events



To establish the prevailing winter wind conditions that would affect drifting snow at the study site the following meteorological conditions were assessed for L.B. Pearson International Airport:

- wind > 15 km/h;
- wind > 15 km/h with snowfall; and,
- wind during blowing snow.

The movement of drifting snow at low wind speeds is negligible, hence, the threshold wind speed of 15 km/h was used to determine the predominant winds that would create snow drifting around the study site.

The first analysis of the average winter winds greater than 15 km/h indicates that the south-west to north and east winds are prevalent (see Figure 6). The second analysis considered was for winds greater than 15 km/h with snowfall (see Figure 7). From this data it is apparent that the north, north-northwest, and to a lesser extent northeast quadrant winds are active in terms of snow storm conditions. The blowing snow events are the final analysis which indicated that the west-southwest, west, northwest, north-northwest, north and east directions prevail (refer to Figure 8).

Therefore, based on the above analyses the following wind directions have been examined during the snow drifting assessment:

- northeast;
- east;
- southwest;
- west;
- northwest; and,
- north

General Snow Drifting Conditions

Site visits revealed a number of small concerns that relate to snow drifting. Figure 13 shows several trees located next to a paved walkway. Locating trees this close increases the amount of snow that will drift onto it. Trees should be placed further back from such areas in order to decrease snow accumulations.

Figure 12 shows an entrance partially located below the adjacent grade. Designs such as this should be avoided where possible, in order to minimize localized snow accumulations.

Several areas on the study site were noted for their effective use of vegetation to control drifting snow. Figure 14 shows a row of small dense shrubs. Using vegetation in such a manner is effective in terms of collecting drifting snow by creating localized catchment areas. Figure 15 shows another group of small dense shrubs. In this case coniferous landscaping protects the entrance to the building, as wind blows snow around the adjacent corner.

Existing Site Conditions and Design Recommendations

The recommendations for the Microclimate Design Guidelines for the proposed Master Plan at the University of Toronto, Mississauga Campus have been developed by combining the meteorological information gathered in Section 2 above along with important existing site features. The following subsections will discuss these features and how the future design should be developed to establish a favourable microclimate. Figure 1 is provided as an orientation plan of the Study site for use during the following discussions:

Existing Trees on Site

The site currently has a large stand of trees centrally located on site (the woodlot). These trees marked "A" on Figure 1 are a mixture of coniferous and deciduous trees that are estimated to be 15+/- meters or approximately 3 storeys high. These trees provide an excellent wind protection for the north/south pedestrian path shown as B on Figure 1. In addition, these trees will shelter the proposed 2 to 4 storey buildings on the east side of the main walkway.

Entry Court (Location C)

The proposed entry court is also somewhat protected by the existing trees (A) but in this location the trees are not as tall or dense as in other areas of the site. This will result in relatively windy conditions at the entry court. The proposed entry court includes a covered walkway from the road northward to the Student Centre that will protect the court from these winds. In order to provide more comfort at this location there should be increased protection from westerly winds. This could be accomplished by planting a row of coniferous trees (D) on the west side of the entry court. Beneath the covered walkway and on the west side, it is recommended that a wind screen be included to provide further shelter from westerly winds as shown on the Master Plan drawings.

Court Yard (Location E)

Several coniferous trees are presently growing in this area.(Figures 9). These trees serve as wind breaks from westerly winds which are channeled into this area. This type of planting is recommended in any large court yards to reduce local wind speeds.

The Quad (Location F)

The open area known as "The Quad" offers the largest source of driftable snow within the development site. The prevailing winds will blow across the site and deposit most of the drifting snow in the existing trees (A). It will be important to maintain a band of trees along the east side of The Quad to provide wind protection for the main north/south pathway in the area

of Location B1.

Sheltered Activity Area (Location G)

Location G has a naturally sheltered area that could serve as an outdoor activity area for the nearby residences. With the exception of some wind exposure to the north this area is sheltered from many of the prevailing winds. If a row of trees (G1) could be added to the north side a well protected area from the wind could be created. This would serve as a barbeque area in the fall/spring and/or an outdoor ice skating area in the winter.

The Five Minute Walk (Location H)

This pathway, at Location H, is aligned with many of the prevailing wind directions and could tend to channel winds in an easterly direction towards the Student Centre. To reduce this effect it is recommended that this pathway be designed with a number of bends to breakup the linear nature of the path to appear more serpentine.

Parking Garage and Athletic Field (Location I)

An outdoor track and parking garage are to be added at this location. In order to maximize wind protection for the track and spectator seating, it is recommended that the parking garage be positioned along the western edge of the track to act as a wind break.

Proposed Buildings 1 to 5

Buildings 1 to 5 are proposed for the northeast corner of the site. Large portions of these buildings are protected by the existing trees (A). As well, the terrain in this area slopes downward from the west to east, starting at approximately the north/south pathway (B). The configuration of these buildings and the stepping of the terraces create protection for local seating areas. An example of such a wind protected courtyard exists at the Kaneff building (see Location J in Figure 1 and Figure 10) and on the east end of the south building.

The main north/south link (B) is protected from winds that are downwashed from these buildings by the 2 storey podium that lines the east side of the path. This feature combined with the existing trees (A) in Figure 9 will create comfortable wind conditions along the pathway.

Where appropriate seating areas should be protected with landscaping similar to that shown in Figure 11. This landscaping will provide added local protection at the benches during windy days.



Figure 9



Figure 10



Figure 11



Figure 12



Figure 13



Figure 14



Figure 15

Precedent - Landscaping in Parking Areas



3.12 Traffic, Vehicular / Pedestrian Circulation, Parking

ROADS, PATHS AND SIDEWALKS

The road system can be developed with two primary systems. The first is an urban system that is the primary organizing and functional route through the Campus. The extension of the new entry road past the Kaneff Centre represents the urban system. The second is a park-like ceremonial system that occurs along the existing Ring Road. The qualities these roads and their edges take on will define their character. Sidewalks will be placed in areas along the road system where pedestrian circulation is likely to occur such as in the main drop-off area and along both sides of the Ring Road, but only in the southern portion. Beyond these areas there is very little pedestrian activity that will take place along the road system and a single sidewalk will serve the purpose. In the residential areas sidewalks are necessary along one side of each road for circulation. The scale of the roads and the amount of traffic they generate require a single-sided sidewalk system.

Paths offer the major experience to the students through the Campus. A hierarchy of paths will mark the varying routes through the Campus. Axial, arterial paths will signify the major connecting routes while informal, more garden-like paths will offer a secondary incidental system through the Campus. A path for bicycles should be incorporated on the Campus that is independent of the Ring Road. This path should connect to the larger circuit of the Credit Valley Trail System. Raised walkways (boardwalks) should be suspended over the watershed, which will also provide dry passage when the water levels are higher.

The path systems need to be developed with a system of planting, rhythm of trees, places to sit or textures on the walking surfaces to provide a diverse and memorable experience.

MISSISSAUGA ROAD

Mississauga Road is the Campus' front door to the community and the region. A balance must be achieved in addressing Mississauga Road to ensure the context of the adjacent community is addressed in scale and presence, while the image of an academic institution is presented. The Campus' residential development along Mississauga Road mediates the scale with the adjacent community. A system of low stone or brick walls along the edge of the property can give an institutional presence to the Campus and form a gate at the main entry

to the Campus.

Development is not tied to any specific road improvements on Mississauga Road, but there is a desire to be a "good neighbour" as the situation will only become more difficult as the Campus expands. The proposed new South Entrance and modifications to the interior routes of the Campus will be costly to build. The best solution from a traffic standpoint is to keep all the entrances -existing and proposed - but create a hierarchy of major and minor entrances. In order to phase these expenses an incremental implementation plan that will deal with the pressure points of the traffic volume on the existing road system in phases outlined below:

- 1 The re-scheduling of some key courses could alleviate this problem at peak times in the short term, but the road configuration should be improved.
- 2 Add left turn lanes on Mississauga Road at the north entrance to improve the operation of this intersection. Traffic signals will be required as the enrollment increases. This will relieve the back-up on Mississauga Road which, at times, extends to Burnamthorpe Road. This has met with opposition from the local residents in the past, but the projected growth requires a reassessment of the situation with the local groups
- 3 The new signalized South Entrance in line with the intersection of The Collegeway at Mississauga Road. This will reduce the traffic on Mississauga Road because some vehicles coming from the northwest will drive down The Collegeway and into the Campus, and those coming from the south will turn in at the new entrance.
- 4 The new UTM Drive, main drop-off and closure of one side of the middle entrance. At this time the traffic signals would be removed from the middle entrance.
- 5 Road and sidewalk improvements be phased as new buildings are constructed.

There are also opportunities in the future (when the UTM grows beyond the projections of the current Master Plan) to develop another north entrance further north, which would involve the construction of a new road that connects to the Ring Road through the wooded area.

PUBLIC TRANSIT

The location of the bus stop on the Campus is not close enough to an indoor space and students have to wait out in the cold for infrequent buses. The transit route is often clogged with cars and the turning radii are insufficient. The existing bottleneck at the South Building will be removed when the new road configuration is implemented. The buses will enter the site at the South Entrance and drive along the UTM Drive to the new main square. They will then exit by the middle entrance. A warm waiting area is provided under the proposed canopy and

ideally there would be a café near by.

PEDESTRIAN ROUTES

- The Five Minute Walk will continue to be an important artery of pedestrian movement on the Campus, but given the direction of the future growth to the north of the South Building, it has become part of an integrated circuit around the UTM Quad. A new residence building is proposed along this walk which will provide some protection, shelter and increased safety.
- Better microclimate conditions for enhanced pedestrian comfort will be created
- Pedestrian routes will be developed that provide efficient and convenient circulation among all campus facilities.
- Weather protection will be provided along major pedestrian routes (where possible) and also at pick-up / drop-off waiting areas.
- Delicate pedestrian links will be formed through the ecological areas so that people can have close contact with the natural features of the site without destroying the flora/fauna. (Boardwalks or other type of raised walkway through ecologically sensitive areas)
- The pedestrian link to Erindale Park will be reinforced
- Pedestrian routes will be developed alongside other routes such as bike routes and roller blading routes.
- Planning standards that deal with safety concerns in terms of lighting pathways, safety phones, cameras, security mirrors, good signage, lots of glazed areas in stairwells, visible police presence, dead-end spaces etc. The standards are similar to those of the City of Toronto.

STREETSCAPE

The Road sections, described on the following pages, illustrate configurations that accommodate pedestrians, bicycles and bladers, layby areas and planting that improve the function and aesthetics of the road systems.

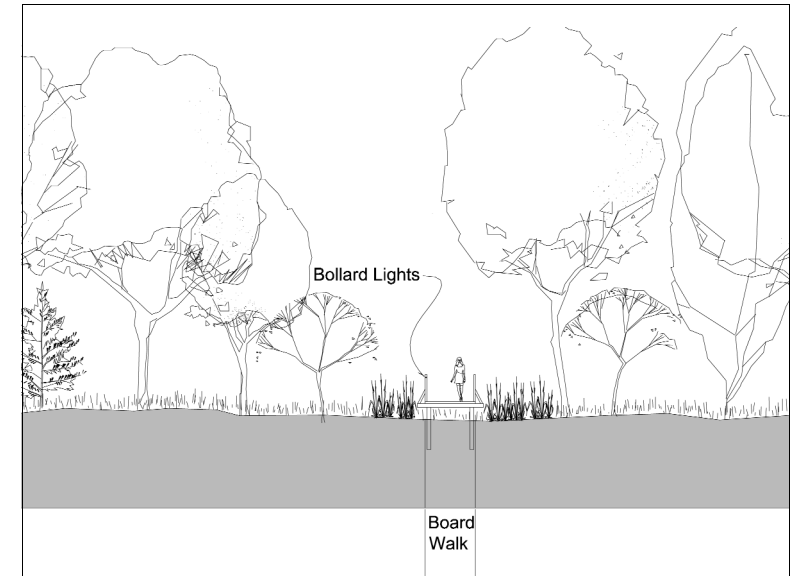

Typical Boardwalk Section

Typical Pedestrian Path

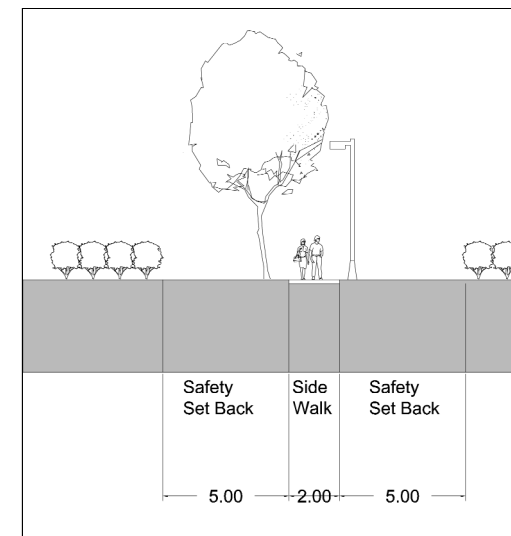

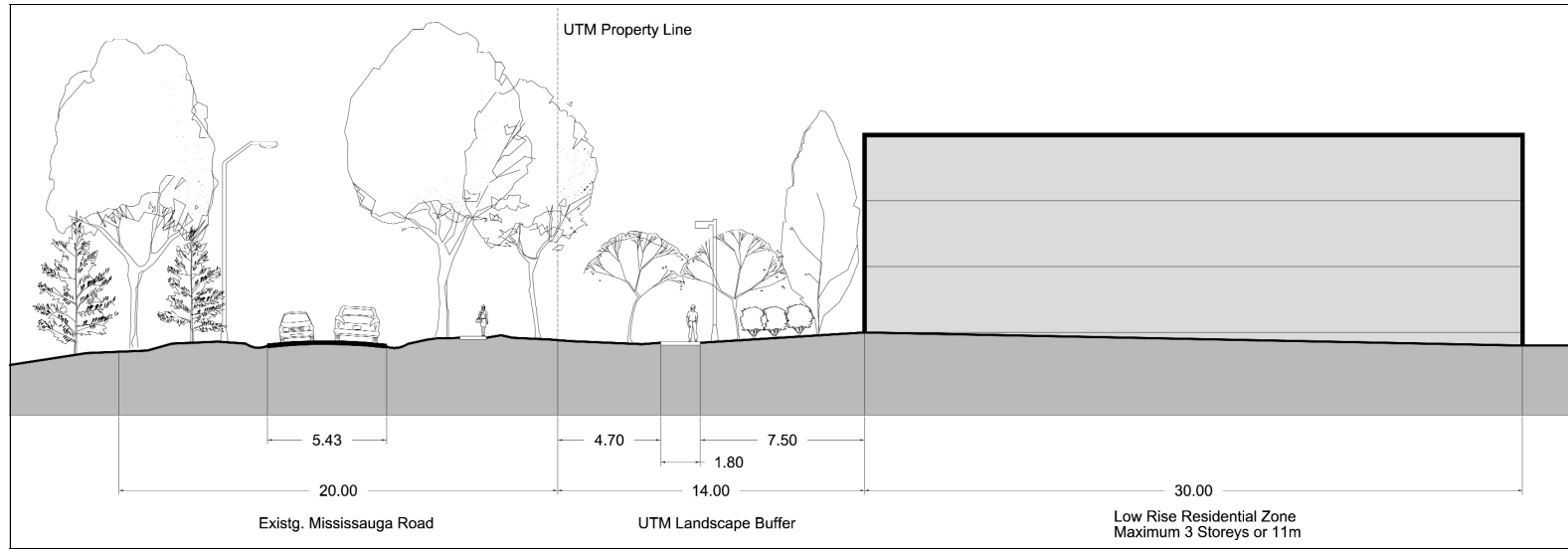

Mississauga Road Edge Section

Mississauga Road Typical Section

The existing sidewalk is in poor repair and meanders the length of Mississauga Road, sometimes in a location that is too close to the narrow driving lanes. The proposed section shows a new "UTM sidewalk" that is inboard of the property line with a deep, enhanced landscaped area (14.0m +/-) to define the UTM precinct along Mississauga Road and preserve the scenic nature of Mississauga Road in a meaningful way. Using the Phase 6 residence as a benchmark for future building setbacks from the property line (13.6m), this still allows a landscaped area of 7.5m between the residence buildings and the proposed "UTM sidewalk" which would have pedestrian-scaled lighting. It also shows a height restriction of three stories in a 30.0m band beyond the 13.6m setback which does not limit the UTM's future residence development plans, and is more acceptable to the local community.

New South Entrance

The new roadway configuration is somewhat awkward because the connection has to be in line with the existing Collegeway road. This means that the road has to swing back in a southerly direction before turning into the Campus grounds. This will be a signalized intersection and the road lanes should be configured to handle the traffic volumes as efficiently as possible. It is unfortunate that the first impression from this entry point is a relative sea of parking. The proposed parking structures adjacent to the UTM Drive should be designed as an integral part of the landscape concept (terraced and working with the grades). The existing middle entrance should be maintained as a more "ceremonial" entrance.

Main Drop Off Section

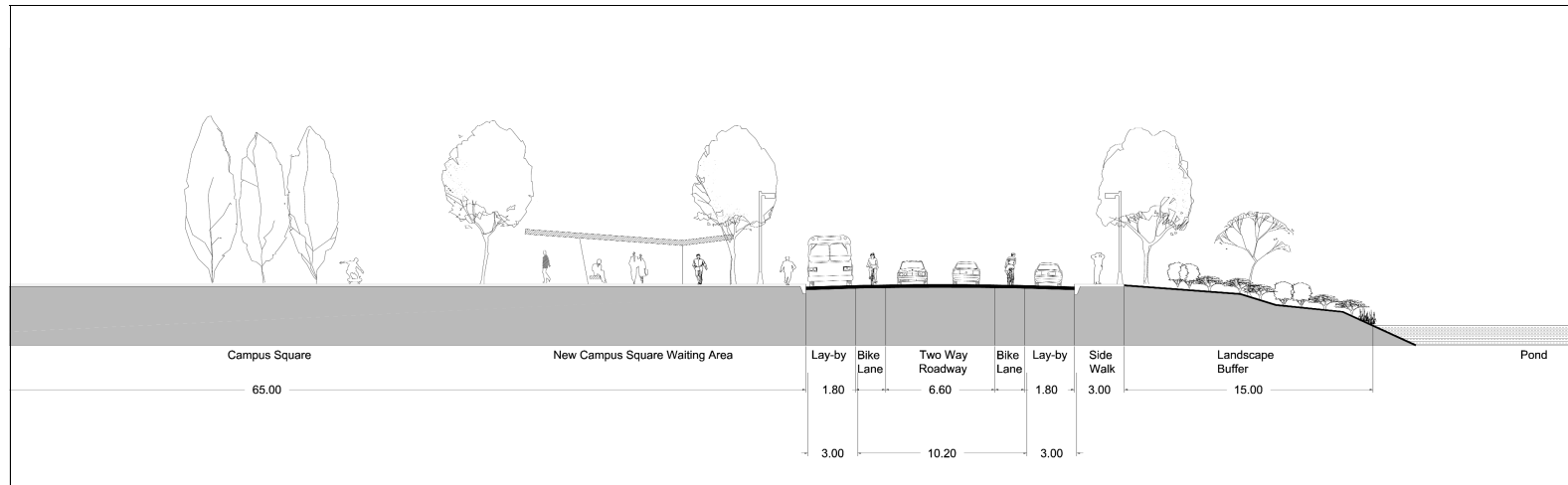

The Main Drop Off - UTM Square

Along the north side of the pond, a long stretch of paving accommodates layby lanes (22 cars each side and buses), bicycle lanes and two-way traffic. Some of these layby parking spots can be identified for those physically challenged. On the pond side a paved surface (min 1.8m wide) undulates along the length of the landscaped zone before the pond edge. There would be no mowing in this landscaped zone and the long grasses would be adjacent to the paved edge. The widening of the road does not affect the pond, the extra width required is taken from the north side. On the other side the sidewalk intersects a new Campus Square which is in front of the Student Centre. In this square there is a bus shelter and canopy that leads one under cover to the Student Centre and the main street spine beyond.

"The UTM Drive"

This is the approach road from the new south entrance that arcs in front of the main drop off area and exits to Mississauga Road at the location of the present middle entrance. The section showed two-way traffic lanes, two bicycle lanes, sidewalks on both sides with pedestrian-scaled street lighting and a double row of trees on either side. This is the only formally planted route in an effort to give this route a more distinctive look.

The North Drop Off - North Plaza

Another drop-off area is proposed at the north end of the Main link and in close proximity to the Library and the Physical Education Building. Layby lanes are adjacent to the North Plaza.

The Ring Road

The section indicates the addition of sidewalks on both sides and the incorporation of a bicycle lane on the outside edge of the road. It is proposed that bicycle routes running free of roads will augment this.

Typical Residential Road

A typical road in the residential areas is shown with narrower driving lanes (to slow down traffic) and a sidewalk on one side only. It was felt that the traffic would not be busy enough to justify bicycle lanes on these roads. It was also thought that less paving would lend more of a residential feel to the roadways.

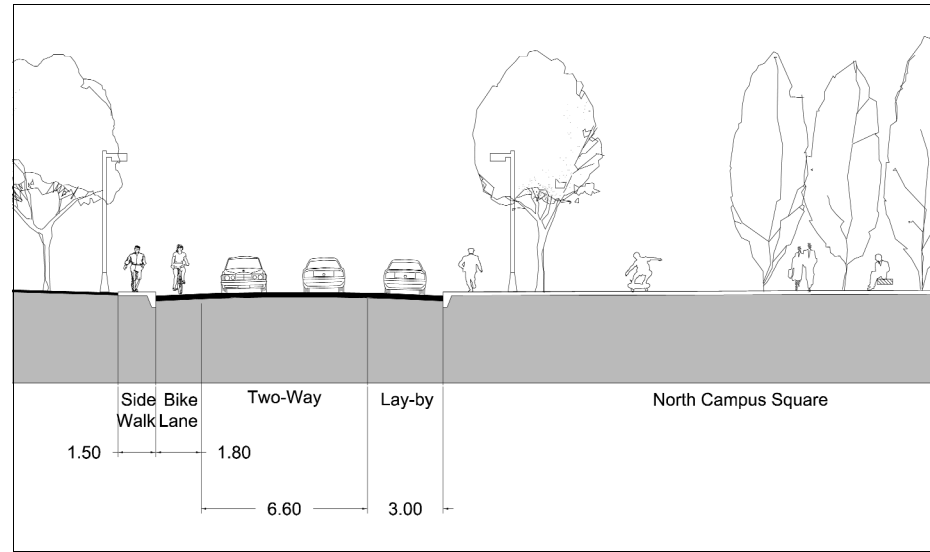

North Drop Off Section

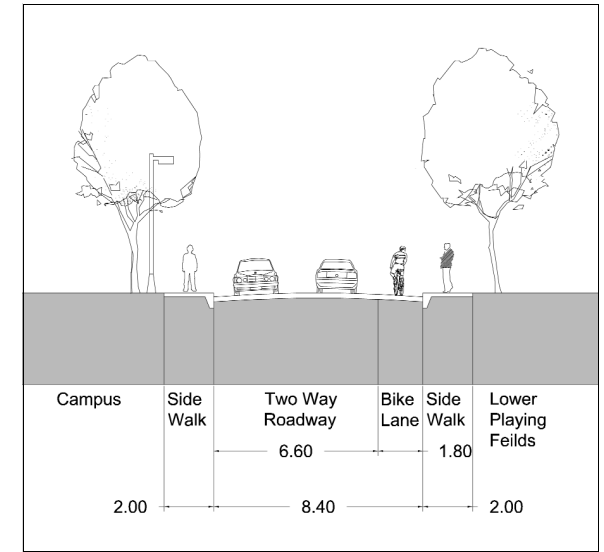

Ring Road Section

UTM Drive Section

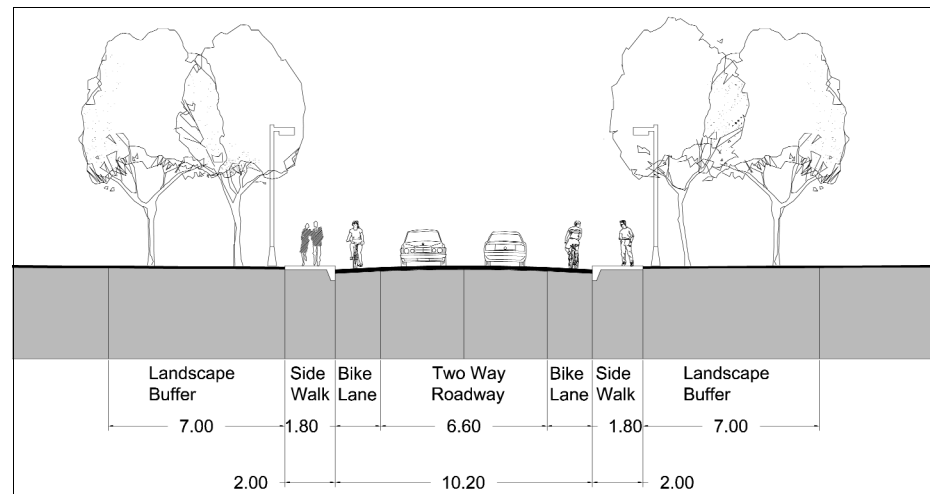

Typical Residential Road Section

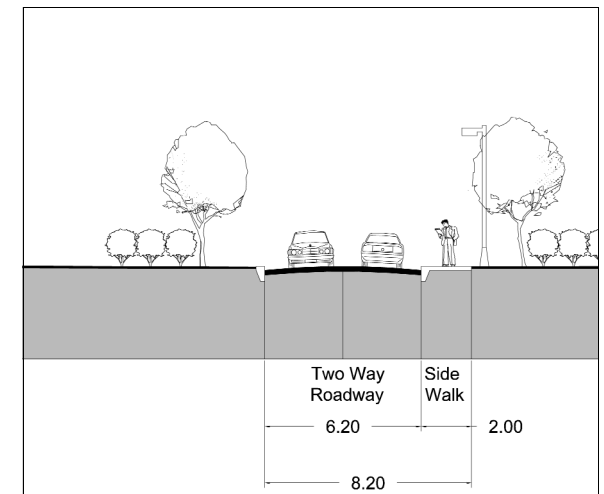

Parking

At the UTM much of the population arrives by car. Currently the effective parking supply rate is quite high - .47 cars per person. The planning of the parking is a complex issue and somewhat difficult to forecast. Already there are more permits issued than there are spots available and this practice will likely continue. Even though other U of T locations have much lower parking ratios, it is unlikely there will be a drastic change at the UTM given the relatively poor transit availability.

In developing the new quantities, it was assumed that the additional parking spaces required would be calculated at .25 cars per person. This reduces the effective parking rate at the full build-out to .36 cars per person. It should be noted that the City parking requirements are substantially less than the current Campus count. Even at the 100% growth scenario, that City would only require 1710 spaces and there are presently 2306 spaces on Campus.

The cost of structured parking was reviewed many times, and it may not be feasible to have parking under the new buildings. The cost is approximately \$20,000.00 (May 2000, figures) per stall. There is no government funding for structured parking and donors are unlikely. The parking costs will have to come out of the UTM's operating budget and permit costs will have to rise substantially if even a portion of the parking was structured. The UTM Master Plan committees still felt that it was important not to increase the amount of pavement on the Campus, and ideally there would be less in order to maintain portions of the attractive wooded areas and a coherent open space plan. This cannot be accomplished without some structured parking. It would also be desirable to phase out the non-residential parking component in the residential sections.

Surface parking, other than existing, will not be increased inside the Ring Road. All parking structures and any new surface lots will be outside the Ring Road. Any remaining, existing parking within in the Ring Road should incorporate some of the suggested landscaping techniques shown for the Orchard Parking Lot in the diagram to the side. This new parking lot demonstrates the "screen and green" strategies for surface parking areas and the trees would be part of the Nursery program discussed in Section 3.11. There were some safety and view concerns, raised by UTM staff and near-by residents, about the proposed parking lot in the old orchard. The location is somewhat isolated and surrounded by trees. Measures to be taken are:

- the parking could be reserved for day use, so that after a certain hour vehicular entrance would be restricted
- a fence could be erected at the tree line
- a 10m clear perimeter between the trees and parking would improve visibility.
- instead of several large floodlights, a greater number of low lights could be provided to reduce the impact on the neighbouring houses

In order to fulfil the current need for parking, additional parking on the North Campus will have to be considered. The location was not finalized, but the lot shown represents the order of magnitude. The parking in the lower east fields, must be planned as secondary uses to the Varsity sports facilities.

It may be possible for the new buildings to accommodate one level of parking below the new structures in a half-down configuration. Since the footings of the buildings must go to this depth anyway, it could be a less expensive approach than typical underground parking costs. The topography of the site could also offer opportunities for hiding the parking from entry and other key areas, while providing at-grade access to the new buildings. Some portions of this parking could be open to natural daylight. It was felt that the Physical Education building in particular could benefit from having parking underneath as it would be a positive feature in terms of encouraging community membership and use of the facility. Some areas of surface parking could be doubled by creating a half-down / half-up parking configuration.

"Screen and Green" strategies for surface parking lots have been considered for the lots that are likely to remain in the 20-year time frame of the Master Plan. Planting at the perimeter and within the larger lots as shown on the site plan improves the appearance and provides some shade. The approach treats the parking areas as courts that are clearly defined and integrated with the buildings and street treatments. Additional accessible parking adjacent to buildings is required.

The large parking structures in the lower playing fields should be design as a terraced or craggy landscape that is integrated with the natural land forms in the area. The field side of this lot could incorporate stadium seating for the running tracks. The parking diagram shows two scenarios - one with a parking structure framing the stadium seating, and the other with no seating and an additional block of parking to the east. The measures taken to improve the aesthetics of the parking lots have minimal effect on the efficiency of the lot and respect practical issues such as snow removal and capital cost.

Orchard Parking Lot with Nursery Planting

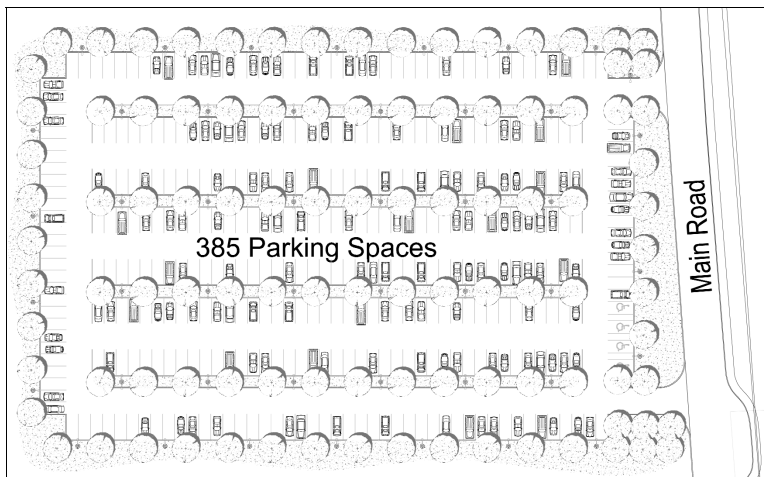

Surface Parking Lots "Screen and Green"

Strips of soil are incorporated in the surface parking areas of a width to accommodate tree planting. In some instances, where the lots are never removed, these trees will be permanent. In others, where the lots are temporary, the tree bands are nurseries for trees that will be relocated when the lot is removed to accommodate new structures. In this way the lots are always planted, whether temporary or permanent.

In the case of the Orchard Lot if a future theatre building, and even an arena is constructed within the illustrated development zones, this lot may become a structured lot and absorb some of the parking complement in the proposed structured lot in the Lower Playing Fields. The trees that were planted in the surface lot would then be available for transplant.

While the Master Plan does not recommend a definitive parking zone, the strategies employed to "screen and green" them could be common. It is also not likely that the parking requirements will decrease given the suburban location of the Campus. Parking revenues contribute to the operating budget of the College. Should the number of parking spaces increase to 3500 with the 100% growth scenario, structured parking will have to be incorporated in order to maintain portions of the attractive wooded areas and a coherent open space plan. The Master Plan identifies options for achieving the target figure as well as "screen and green" strategies for these large paved areas that respect practical issues such as land use, snow removal and capital cost. Efficient, multi-level lots have also been considered for key areas in close proximity to highly populated areas of the Campus.



Precedent - Terraced Parking at Ohio State University

Precedent - Sculptural Parking- Parkhouse / Carstadt, Amsterdam, Holland by NL Architects



3.13 Servicing

Loading

The guidelines for improving service access to the existing and new buildings are as follows:

- Wherever possible double-up the use of existing and new loading and service facilities by linking new buildings on the Campus. This is illustrated on the Master Plan site plan. All of the proposed service courts serve at least two buildings and they are all directly accessed from the Ring Road.
- The grading of the site offers opportunities for locating the loading and service areas of the buildings in a manner that screens these activities.
- Limiting access of service vehicles to particular parts of the internal road system will make the interior of the Campus safer and less congested.

Overview of Site Servicing

The original Master Plan for the campus had anticipated the expansion of academic facilities on the site. Several assumptions about the nature of the service infrastructure have changed. As a result, several aspects of the initial servicing are not appropriate for the current plans. This is the situation with respect to building mechanical systems.

The site power supply appears adequate for the initial level of development, but must be evaluated further as the full development of the site is reached. With respect to stormwater drainage, policies have changed since the development of the original site that now prompts an alternate approach to the handling of stormwater on the site. Stormwater must be treated for quality concerns before it can be released to the Credit River.

Sanitary systems were not developed to cater to the full expansion of the site. As a result, new sanitary mains must be added to service the expanded facilities.

The water distribution system was developed to accommodate the expanded site. Minor additions however, will be required to suit the expanded plan.

HYDRO

As indicated previously, there is excess capacity in the main supply to the campus. This allows for redundancy in the power system. If transformer redundancy is not required, then additional loads can be placed on these transformers and effectively double the electrical loading of the entire service. Further investigation will be required to determine if there are any physical restrictions for adding onto the main switchboard. However, if the transformer

redundancy were desired, then an upgrade to the primary distribution substation would be required. Based on the ratings indicated by GT Wood, the existing switchboard could be reused.

With respect to the electrical servicing for new buildings on campus, it is recommended that new local building substations be created with transformation and switchgear provided in each building similar to the existing distribution system. Alternatively, consideration should be given to a high voltage loop type distribution system for improved reliability of the service conductors.

It is anticipated that the power requirement of the campus will increase by 50% with the 50% Growth Model and by 85% for the 100% Growth Model, however, this is dependant upon the use of electricity and cooling of the buildings. It is recommended that more use be made of natural gas for heating the new buildings. Solar power can be used to provided lighting to the quad areas and for non-critical power needs. At this time their cost is decreasing, however, they are more costly than conventional power sources.

The University should instigate a program of load profiling. This should be done at the primary supply point as a minimum, but consideration should also be made to profiling the loads at individual buildings. This would allow the University to better evaluate its energy usage.

WATER SUPPLY

The 300 mm diameter main is sufficient for domestic demands of the site. The 300 mm diameter should also be sufficient for fire demands. The new structures should not individually exceed the floor area of the existing South Building Complex. As a result, the fire demand should not increase. The existing pressure on the road is sufficient for the supply to the site. No complaints of low pressure have been registered. Elevations of new developments do not appreciably vary from existing facilities, therefore, the ambient pressure is not anticipated to vary from the existing complex.

One important consideration for the site is the provision of redundant supplies to the system. Currently, there are two connections to the system on Mississauga Road. The trunk on this road can be supplied in two directions. One link in the site's system is not supplied from two sources. There should be a new pipe between the 300mm diameter pipe servicing the athletic field and the watermain adjacent to the Central Utilities Building. This will avoid standing water in this run of pipe and reinforce the trunk system through the site.

The enlargement of the pond south of the South Building may require the removal of a section of 200mm diameter watermain. A new main should be constructed along the new entrance road. Each new facility will be serviced from the trunk main system. Sizes of service connections will be determined as the facilities are developed. The 200mm diameter stubs should be sufficient for the new buildings.

If low pressure were observed in the future, it would be advisable to develop a water system model for the site. This could then serve as a tool to evaluate the impact of new facilities and demands. It would also be advisable that private meters be incorporated into new and existing facilities. This will allow the University to monitor the water usage of each building and to determine if water is being lost elsewhere on the site. This monitoring program could assist to maintain and manage the loss of water through leaky pipes thereby reducing the expenditures for water.

SANITARY SEWERAGE

The main connection to the regional trunk sewer is satisfactory to meet the expanded demand of the site. As the new buildings are added, another sewer will be required to service the expansion. This sewer should be sized to meet the needs of all the new facilities and its alignment chosen to suit the footprint of the new additions. As the residences are added around the wetland the sewer should be extended to this location. The need to increase the size of the existing 150mm diameter sewer in this area should be investigated.

STORMWATER AND SITE DRAINAGE

As the campus is developed, more of the surface will be covered by impervious materials, resulting in increased runoff. There will also be more pollutants washed of the site. These are all a concern for the CVC and other environmentally authorities. To address these concerns, a comprehensive Stormwater Management Study should be undertaken. These would satisfy approval concerns and provide the University with answers to concerns about the long-term health of the wetland and pond system. It would also set parameters for the construction of the expanded facilities.

We anticipate that the parking area, north of the North Building, will require its independent oil and grit separator as part of the treatment train and may require some quantity detention depending on the capacity of the downstream pipe system.

The storm sewers between the Central Utilities Building and the south parking area must be

reviewed and their capacity determined to evaluate if they can accommodate the expanded flows. Alternately, a new sewer may be required with a possible storm pond near the edge of the valley.

SITE SERVICING INVENTORY

This study was significantly hampered by the lack of accurate and accessible information. As a prelude to the expansion of the site, an accurate inventory of the existing infrastructure should be completed. The information should then be accurately mapped. Monitoring of sewage outflow would provide the site designer with accurate information on which to base his design.



UTM - Main Utility Plant

3.14 General Program Distribution

Masterplan 2000 proposes that the majority of new academic buildings be built in the area designated on the original Master Plan. In contrast to the original Master Plan which proposed a large superstructure, Master Plan 2000 proposes individual buildings of distinct character will ensure that the Campus operates on a human scale with structures and open spaces that reflect that scale. In addition to the new buildings, there are existing program areas on the Campus such as the library, student and food services that are not ideally situated and could be consolidated to accommodate expansion. Locating the more public services and "retail" functions along the main arteries of the Campus will add life to the passages and make these programs more profitable.

The new buildings are not likely to be single-use structures, but may incorporate groups with similar space requirements or groups that benefit in a symbiotic way from being together. The coloured diagrams of the North and South Buildings show the existing distribution of the departments. These will be useful to illustrate available spaces in the building when large areas such as the library and athletics move out of the South Building and in to their own facilities. A brief list of the components that could vacate the South Building include:

| | |
|----------------------------------|-----------|
| Library - | 4206 nasm |
| Athletic Facilities - | 2395 nasm |
| Food Services - | 1465 nasm |
| Miscellaneous Student Services - | 763 nasm |

In consideration of any program shifts within the existing buildings some of the uses suggested for the vacated space in the South Building include:

- Move Psychologists out of the lower level space and into an area where there is natural light, a "people-friendly" space suited to research in child development and the aged. The lower level space could be used for additional labs (biology and physics) which do not require natural light.
- Convert gymnasium into a lecture theatre with access possibly from the second floor.
- the Forensics department could move to be closer to the Biologists so that they could share resources. There is desire to have a biology course that involves the use of body parts, the storage of which would have very specialized technical requirements.
- The Archaeology group requires a lot of space for layout space and artifact collections.

This could be a program ideally suited to the space of the library, allowing for some more public, museum-like displays. Compact storage can be accommodated here because of the floor load capacity that was designed to take book stacks.

Portions of the North Building that are vacated will be maintained as a staging space for displaced areas, and used for lower maintenance academic activities such as study space, storage, seminar rooms etc.

There are no proposed changes to the program of the Kaneff Building, except that the Art Gallery would ideally be moved to a more public space along the Main Link as defined in the Master Plan.

Buildings programs will be developed to include ancillary uses. This will include a variety of student activities and facilities to be located close to main campus routes in order to increase the visibility of active spaces and integrate the outdoor environment with the interior. The new buildings will be designed to be flexible so that changing occupancies and future trends can be accommodated.

The new buildings to be developed have been divided into 3 categories:

- Buildings currently funded
- Buildings with User Committees established
- Future buildings

These Buildings are described in Section 3.8.

3.15.1 Funded Buildings

CCIT BUILDING

The UTM and Sheridan College were awarded funding for a new program in Communication, Culture and Information Technology to be housed in two facilities, one on each of the two Campuses. The Joint initiative will create a distinctive niche in a rapidly growing area of study. The building will be completed for the 2002 academic year. The CCIT program is intended to be cross-disciplinary and is expected to sustain about 1/3 of a suggested 60% increase in total enrollment. The CCIT initiative will give students the knowledge, skills and critical understanding of communication and the new communication technologies that will keep them in control of the tools that shape their world.

The program calls for a combination of Classrooms, Laboratories, Offices, Administrative spaces and possibly a Library and Student Support Space for the Science and Humanities disciplines.

The CCIT will be the first building in the implementation of the Master Plan. In order to start the process of consolidation of the Campus buildings, develop the first leg of the Main Link that bordering the UTM Quad, form the first of a series of courtyards and preserve much of the existing parking areas, it has been positioned north of the South Building in an "L" shape.

Conceptual Image of Proposed North Plaza, CCIT and Main Link Entrance



3.15.2 Buildings with User Committees Established

STUDENT RESIDENCES

The Master Plan will have to be flexible in order to accommodate a range of requirements for residences. The target figure for the number of residence beds that has been set by the University of Toronto is 22% of the FTE student count. These figures are shown on the COU Growth Projection charts on Page 20 for the various growth scenarios.

Medium density residences (similar to the Phase 6 development) will be encouraged in order to create a smaller footprint, greater connection to the outdoors and more opportunities for shared spaces and interaction. They will be closely and strategically planned in their consecutive phases.

The Master Plan provides two new residence sites that will fit 200 beds each. These sites respect the boundaries of the watershed area, the knoll adjacent to the Ring Road at the west end of the Five Minute Walk, the woodlot and retain the Theatre building, and the Coleman House.

When the east half of the middle entrance road is removed, there is a large site available for a new residence project. There are also potential future options for developing new residence sites through the gradual demolition of some town house blocks that would clear space for new, fully accessible residences of greater density. The preferred site for the next phase of residences would be the north site beside the current theatre, north of the environmental area. A residence on this site would help reinforce the 5 Minute Walk and the Quad and bring student life closer to the centre of the campus.

3.15.3 Future Buildings

LIBRARY

The library is presently undersized, at 56% of the COU standard (existing area = 4206nasm, 50% growth area required = 8591nasm, 100% growth area required = 9316nasm). The increase in space required would make it difficult to remain in the South Building, and there is limited capacity for stack space in this building. A new building that houses all or most of the library facilities seems logical and moving the library out of the South Building .

The library is used by all three academic divisions and should be central location along the main lines of circulation so that it is convenient for use between classes. It should also have a presence at grade, which could be associated with a gallery and / or a small amphitheatre for readings and performances. There is also a synergy between the library and the Academic Skills Center that should be developed. The library is open late most nights, so personal safety is an important issue. Placing the library in a high-traffic, well lit area that is in close proximity to public transportation, drop-off and pick-up areas and parking lots will help address this concern. It must have a secure entrance / exit and to ensure a speedy response time.

The library should be designed to be fully accessible to those physically challenged. There are frequent shipments that leave and arrive at the library, so access to the loading area should be convenient. The load-bearing capabilities of the new building must be designed to allow for expansion of stack areas. The Campus infrastructure must ensure an adequate power supply to the new library location and future wireless technologies that require receiver capabilities on rooftops should be considered.

The Library is positioned in the Master Plan to form the second leg of the Main Link and the second courtyard space. It has access to the North Plaza Drop-off area and is serviced directly from the Ring Road.

SCIENCE WING (connected to the South Building)

Doubling the student population would double the requirement for both research and teaching facilities. Currently, the space available is far too tight and storage rooms are being converted into classrooms and offices. The preferred location would be near the existing labs, so that activities such as chemical deliveries and security could be streamlined.

PHYSICAL EDUCATION FACILITIES

The current athletic facilities are less than 50% of the COU standards. They are in sub-standard space on the lower levels of the South Building and many of the rooms are not suited to their use. There is no connection with the outdoors. The facility was originally designed for a male-dominated college of 2500 students. The present figures are 6400 students and 500 faculty and staff, 60% female and very diverse culturally. A top priority for the Campus is a new facility that relates to the vision statement that the Campus be one where the whole person is educated within a fit and well environment. It is important to have a philosophy of integration with the natural environment and a sense of spirituality of the outdoors.

An ambitious program has been produced for a new building that would bring the facilities up to the University standards and accommodate the COU growth scenarios. The funding for such a facility would have to be raised by the University as no government funding is available for non-academic buildings. It was suggested that the UTM make new investigations into partnering options or attempt to secure City / Corporate sponsorships. The demographics suggest that a Physical Education Centre would be welcomed by the community. The Campus is envisioned as a regional center for physical education and a place that is a major draw for the community - a home for the community.

The COU generated figures suggest that the Physical Education facilities should be approximately 13,500gsm. The preliminary program developed by the UTM called for a building with the following elements:

- Facilities for physical activity including a triple play space gymnasium with indoor track, 25 m swimming pool, Teaching Studio, Fitness Centre, Squash Courts, Locker Rooms, Main Entrance area with administrative areas adjacent
- Convenient access to intramural playing fields and outdoor skateboarding facility, volleyball, Frisbee, pick-up football, smaller group sport spaces, etc.
- Child Care and Family Resource Centre facility with secure playground area
- Health Services and possible an outreach to the McIntosh Sports Medicine Clinic

In anticipation of growth, it is important to consider the outdoor varsity sports facilities that will be required to maintain a University-standard athletics program. The area on Campus where there is enough space to accommodate these facilities is the lower playing fields. This should be planned as an integral part of the Master Plan, and include space for:

- 3 playing fields (one would continue to be in the new east UTM Quad) the other two are for football and soccer
- A full 6-lane track
- Some stadium seating
- 8 tennis courts with all or some "bubbled" from mid October to April incorporating some seating, waiting area overlooking the courts and other outdoor facilities.
- Baseball diamond
- Campus fitness trail for non-motorized movement, interconnecting to key locations on Campus.
- Footprint for future skating arena

The summer session accommodates a number of programs, conference services and other activities that serve people from age 4 to 64 including:

- Approximately 2500 students (with courses taking place mainly in the evenings)
- 4-5 summer camps with close to 200 children a week, aged 3-16. Activities include crafts, sports, tennis, leadership, environmental camp, science outreach and the Peel Summer Academy.
- CISS (international student program) fills the residence with international students and uses the physical education facilities and language labs.
- numerous business groups and conferences that use the lecture halls and residence facilities.

The Physical Education Complex is shown on the Master Plan at the North end of the UTM Quad. It is adjacent to the Main Link, informal playing fields and the Theatre Building and has access to the North Drop-off. It too is serviced from the Ring Road.



The Existing UTM Quad - Leisure and informal sports

Precedent - Image of possible UTM Quad





Precedent - UTM Quad Informal Amphitheatre created with level change
 Parc de l'Estacio del Nord, Barcelona by Cubiertas y Mzov

CHILD CARE FACILITIES

Currently the Child Care facility is accommodated in two town houses, which are not appropriate for this function. It is envisioned that the Child Care would be incorporated into the new Physical Education facility. The use by children is constant all year. There are many families that live on Campus year round. Recreation for children and day care programs is not only an issue for the summer camps, but year round.

The facility will accommodate 57 children from infants to preschoolers in full time and part time programs as well as emergency drop-in care. The DNA standards for indoor space use a figure of 9.3sqm per child which would yield 530nasm or 880 gsm. The same standards for playground space use a figure of 5.6sqm per child which would yield 319sm.

A program for informal evening care and flexibility to care for children up to 12 years of age should be considered. Other service parameters to consider are in association with the Child Care facility are the Child and Family Resource Centre and Research and observation by academic units. A drop-off area and parking should be near by for use by parents as well as for deliveries.

Precedent - UTM Quad - Contrasting Sculptural Forms
 Parc de l'Estacio del Nord, Barcelona by Cubiertas y Mzov



THEATRE BUILDING

The Theatre and Drama program contributes greatly to the cultural life of the Campus and the public profile of the UTM. Their present space is largely housed in "temporary", converted or portable buildings. They are not adequate and do not project a very good image of the University. Any new space for this group would function most effectively as dedicated facilities that provide for public performances. All of the facilities must also be grouped in one area or, ideally, one building. A recent report from Sheridan College discusses the idea of using the theatre for dual purpose as an auditorium and indicates that a hybrid degrades the use for either intended purpose. If the theatre must be shared, it is important that the building be designed as a theatre and used secondarily as a lecture auditorium. It may be difficult to schedule lectures in the space since it will have to be used by the Drama department for rehearsals, setting up the stage sets etc. - all activities that do not have fixed schedules.

One of the proposed locations for a new Theatre Building is the property to the west of the Physical Education Building. There are several reasons this adjacency:

- Sharing of some facilities such as dance studios
- They both have after-hours use and the accompanying safety concerns
- Access to the Orchard parking and the drop-off area.

LECTURE HALLS

The number of lecture halls is insufficient. The largest one, in the Kaneff Centre, is always over booked and many classes have to be scheduled twice since it is not large enough. The current situation requires one 500-person lecture theatre and at least one more 300-person theatre. Lecture halls should also be suitable for large final exams. These can be used by the summer conference activities which are revenue-generating for the UTM. Larger lecture facilities, equipped with breakout rooms, would attract more conferences.



Precedent - Forest Path



Precedent - Pedestrian Path leading to Five Minute Walk at the UTM



Precedent Planting - Wetland grasses

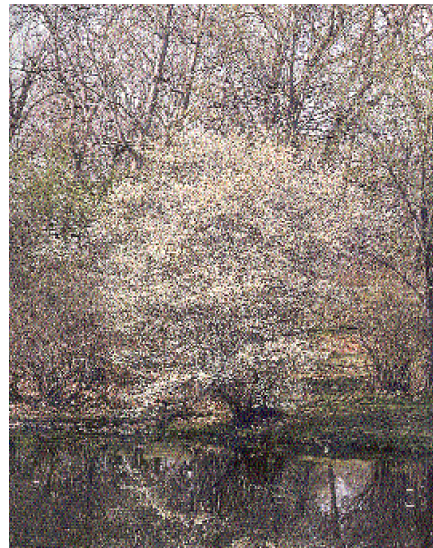

Precedent Planting - Spring Flowering Serviceberry

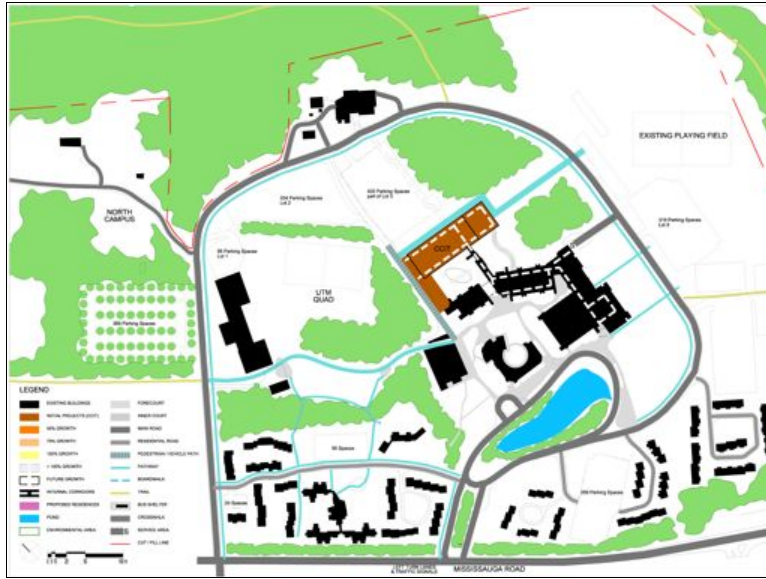

1 - Funded Projects (CCIT)

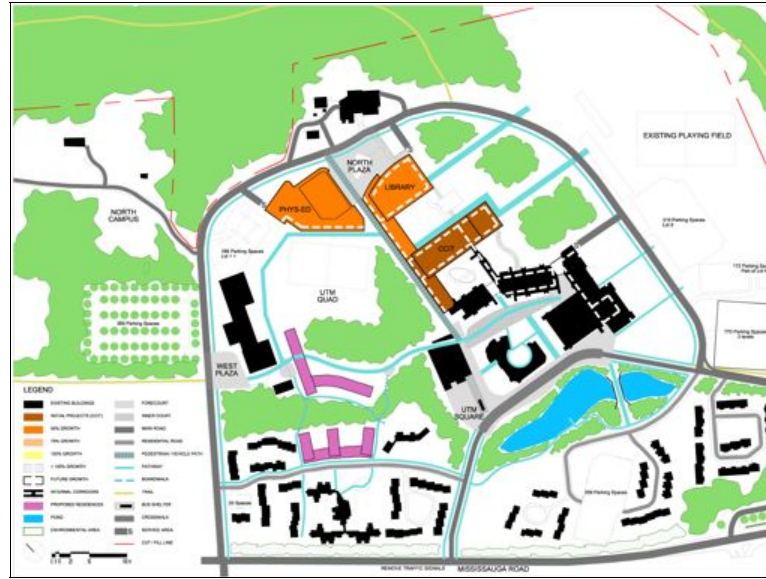

2 - 50% Growth

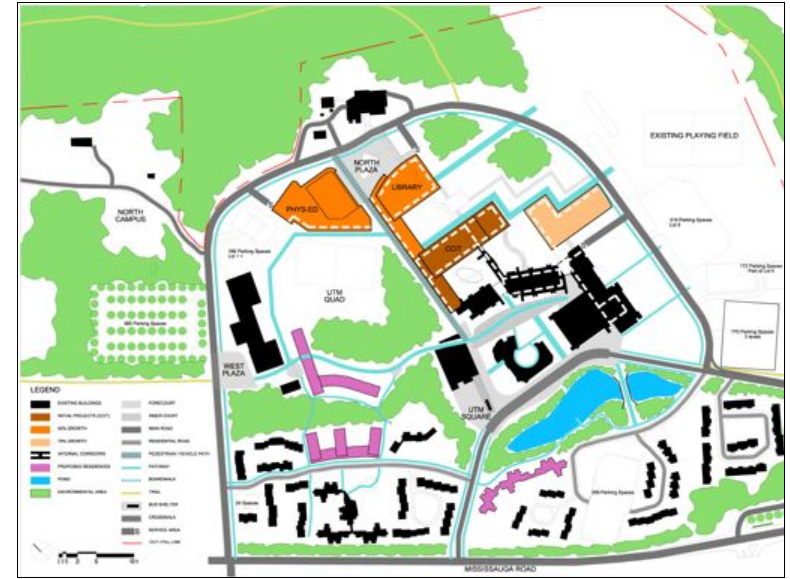

3 - 75% Growth

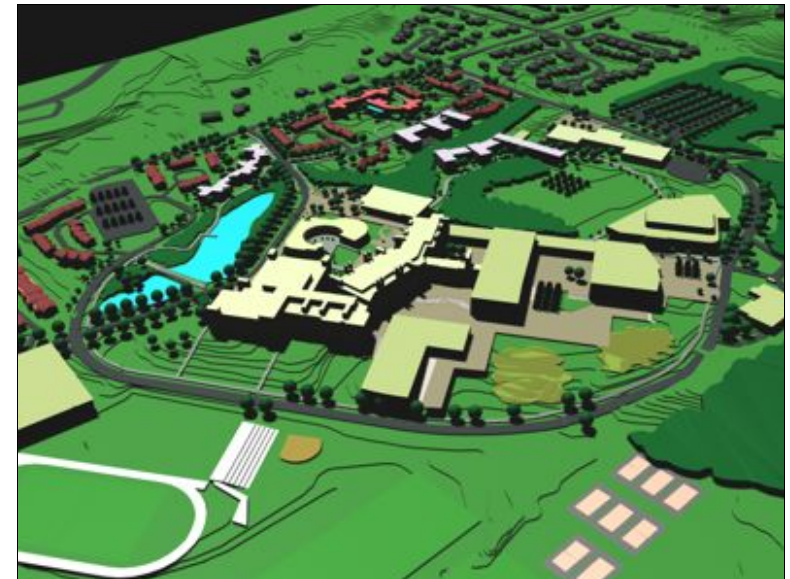
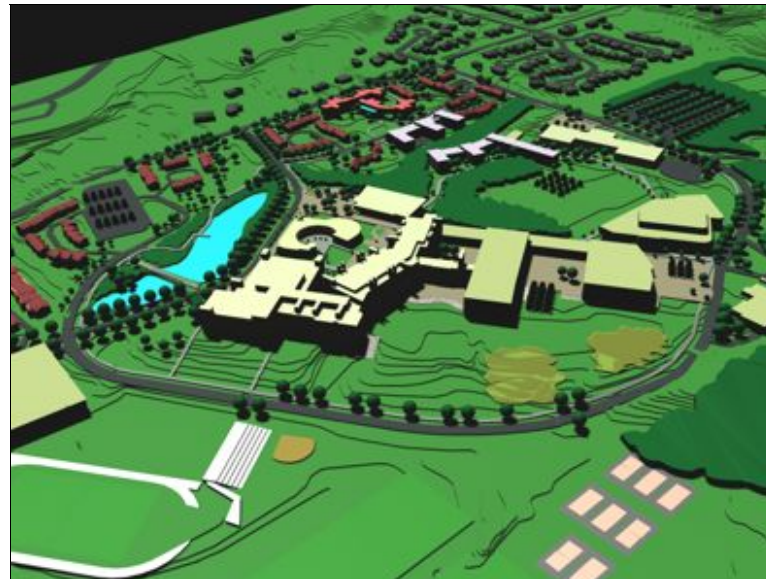

3.17 Phasing Plan

1 - FUNDED PROJECTS

CCIT Building, South Building reconfiguration, Additional Parking.

2 - 50% GROWTH

New Library, Life and Physical Education, Residence (Phase 7 & 8 - 400 beds), Additional Parking and the remaining construction to fulfill 50% growth requirements according to COU figures. The sequencing of any of these buildings is dependent upon funding.

3 - 75% GROWTH

Fulfill 75% growth requirements according to COU figures.

4 - 100% GROWTH

Fulfill 100% growth requirements according to COU figures.

5 - > 100% GROWTH

Additional build out beyond the 100% growth requirements.

Note: there is potentially an excess of development area available without using any of the reserve area on the North Campus.



4 - 100% Growth



5 - > 100% Growth

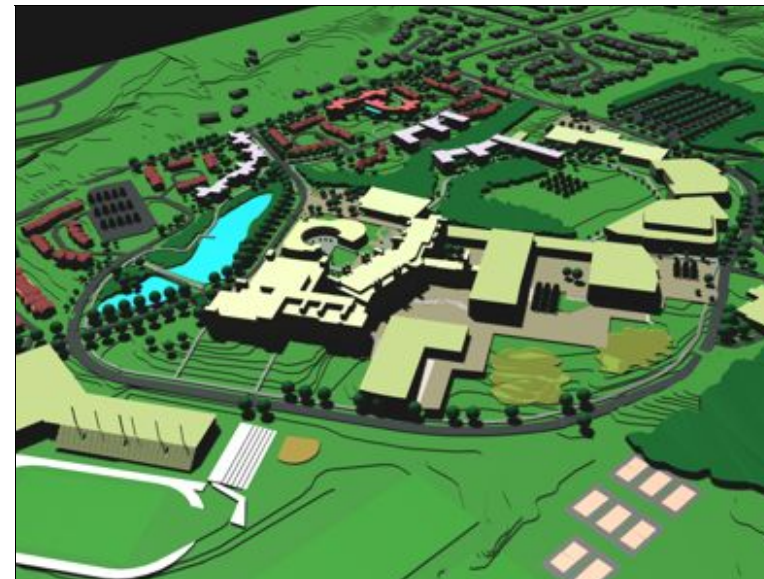

4.0 SITE SERVICES / REGULATORY ISSUES

4.1 UTM Plant / Site Services Evaluation

OVERVIEW OF FACILITIES

The current services on the campus reflect both the original Master Plan for the site and an ad hoc construction program since the development of the original site.

The original plan foresaw the creation of a central utilities complex that would supply heating, cooling and other utilities to the main academic buildings on site. With the construction of the South Building, a tunnel was installed to provide these utilities to this building and future buildings to be constructed off this spine.

As new structures have been added, this plan has been abandoned in favour of decentralized utilities and mechanical systems. Residences constructed on the west boundary of the site have independent heating and are serviced from Mississauga Road. Newest academic buildings have been constructed with a combination of electrical and gas heating that are independent of the Central Utilities Building.

Initially, trunk municipal services were set out and constructed to the original plan. New works have been largely connected to those trunk services but have also been adapted to the needs of each particular expansion.

MECHANICAL/ELECTRICAL SYSTEMS

The Central Utilities Building was constructed with the vision of servicing the Academic Complex through this central location. The plan envisioned a lower operating cost through the centralization of the mechanical Heating Ventalating and Air Conditioning (HVAC) systems. When the initial construction of the campus was designed, this was a reasonable approach. Today there have been advances in the provision of HVAC services that have favoured the movement to decentralized equipment. The facility was originally constructed with large boiler units. These have subsequently been replace with smaller units.

The following is a general review of the existing electrical site servicing for the University of Toronto at Mississauga (Erindale) Campus. The findings are based solely on conversations with consultants GT Wood and with Mississauga Hydro.

The electrical service for the entire site is fed from the Mississauga Hydro grid at 44,000 volts, to a substation located in the central services building. The substation contains two 5,000

kVA transformers which in turn feed a double ended distribution switchboard at 13,800 volts. The buildings on the campus are radially fed from this switchboard to local building substations.

Through conversations with Mississauga Hydro, it has been determined that the peak demands on these transformers over the last 12-month period were 1934 kW and 2391 kW. Assuming that the facility has a relatively high power factor, each transformer is approximately loaded to 50% of its capacity; offering full transformation redundancy. If one transformer should fail, the entire campus could be fed from the other transformer by closing the tie-breaker on the switchboard.

WATER SUPPLY

The water supply is provided from Zone 2 of the Region of Peel Water Distribution System. The campus is located at the top end of this pressure district. According to discussions with the Region of Peel, the Region does not have accurate flow and pressure data for the area but expected the pressures of the system to be within the 415 to 485 kPa (60 - 70 psi) range. The pressure zone extends north to Britannia Road and is within the normal operating range of 275 to 700 kPa (40 to 100 psi) that is prescribed by the Ministry of the Environment.

The Peel system derives its water from Lake Ontario. The Lakeview Water Treatment Plant (WTP) draws water from approximately 2 km offshore and pumps treated water into the system. The Lorne Park WTP also draws water from offshore. The distribution networks for the two plants are interconnected. As series of reservoirs and pumping stations transmit the water to a 400 mm diameter main running along Mississauga Road.

The campus draws water from the water main on Mississauga Road. A 400 mm diameter main provides a connection from the street main, south of the current south entrance of the ring road, to a location southwest of the Kaneff Centre. This supply splits into two 300 mm diameter trunk mains.

One 300 mm diameter branch follows the Ring Road to the athletic fields. This provides services to the southerly residences and provides fire protection south of the South Building and to the parking areas.

A second branch traverses the campus between the South Building and the new Student Centre enroute to the Central Utilities Building. Service stubs from this main provide water to the South Building, Kaneff Centre and Student Centre. The line was also designed with service stubs for future academic buildings. A second 300 mm diameter main draws water

from the 400 mm diameter main on Mississauga Road. This is located at the north entrance, north of the existing residences. The trunk main follows the ring road to the Central Utilities Building where it connects to the other lead.

A 200 mm diameter connection to the northerly main supplies the northerly residences. Other connections supply the North Building and the outlying field houses and Principal's residence.

Records obtained through the University show that the annual usage rates over the last three years were:

| Year | Usage | | Rate per Student (Note 1) |
|---------|-----------|--------|---------------------------|
| | (Galx103) | (m3) | (L/student/day) |
| 1996/97 | 24,339 | 92,130 | 82.9 |
| 1997/98 | 23,730 | 89,830 | 80.9 |
| 1998/99 | 24,990 | 94,600 | 85.2 |
| Average | 24,353 | 92,190 | 83.0 |

1 Assumes 80% of the usage occurs during the school season from September through April and that the average day represents 18% of the flow for the average week. It also assumes 4570 students.

The full-time attendance was also obtained and the average daily usage rate per student was calculated. These values are given above. The average value over the three years was 83.0 L/cap/d. This value compares to MOE guidelines of 70 to 140 L/cap/d.

SANITARY SEWERAGE

The Region of Peel has recently taken over the responsibilities of a 1650 mm (64 inch) diameter sewer, running up the Credit River Valley, from the MOE. This sewer system services most of Mississauga and Brampton and conveys sewage to the Clarkson Sewage Treatment Plant (STP) located north of Lakeshore Road.

A 450 mm (18 inch) diameter pipe was constructed from the area of the south parking lots to the regional sanitary trunk. At a minimum slope of 0.35% (the minimum slope allowed by the Region of Peel's design guidelines), this pipe would have a capacity to handle 169 L/s of sewage flow. Assuming a catchment area of 48.5ha, the pipe could accommodate a popu-

lation of 16,600 equivalent persons or over 25,000 students (using 0.66 equivalent persons per student).

From the junction in the south parking area, the sewage collection system branches out to service the residences along Mississauga Road through a 300 mm diameter sewer.

A second branch services the South Building Complex. A 150 mm diameter pipe also extends north from this complex to service the new Student Centre, Coleman House, the North Academic Building, some portions of the residences and other miscellaneous structures.

A third branch comprising a 300 mm diameter sewer extends from the south parking lot across the athletic fields and then northward to the Central Utilities Building. The study team reviewed drawings made available by the UTM staff. The team also reviewed drawing files at the City of Mississauga Plumbing Department. We were not able to locate sufficient drawings and records to permit us to identify the entire sewer system. We do not have information about the design slopes and flows nor the as-constructed elevations or features of this system. As such, an assessment of the adequacy of the existing system to meet current demands and future needs is limited.

As indicated previously, the 450 mm diameter sewer should have more than enough capacity to handle the flows from the site. Likewise, the 300 mm diameter pipe serving the residences should also have adequate capacity unless extremely shallow slopes exist on this pipe. We judge this unlikely given the topography available on the site. The 300 mm diameter sewer serving the Central Utilities Building should also have considerable capacity to handle current flows from this source.

The capacity of the 200 mm diameter sewer serving the core of the campus is somewhat more questionable, particularly as it extends as a 150 mm diameter pipe past the South Building. Again, without knowledge of the existing slopes of this pipe, it is difficult to assess its capacity to handle the existing and future flows. The current population of the campus is shown below. A number of residences are connected to sewers on Mississauga Road. The trunk to regional system services the remainder of the campus. Table 2 indicates the estimated existing loading on the system.

Table 2 - Sanitary Sewer Loading

| Population | Estimated Sewage Rate (Lpcd) | Estimated Sewage Flow (L/s) |
|--|---------------------------------|-----------------------------|
| 7001 Residents (connected to system) | 302.8 ² | 2.5 |
| 1501 Residents (not connected to system) | 0 | |
| 4570 Students | 200 ³ | 10.6 |
| 314 Staff | Included with flow for students | |
| Subtotal | | 13.1 |
| Peaking Factor (based on 3700 persons) | | 3.36 |
| Total Domestic Flow | | 44.0 |
| Infiltration (based on 48.5ha) | | 9.7 |
| Total Flow | | 53.7 |

1 Estimated (to be verified)

2 Based on Region of Peel Guidelines

3 From on Region of Peel Guidelines, where each student equals 0.66 students

The total annual water used at the site was approximately 92,000 m³. Assuming that 80% of this use will occur between September and April when the majority of the students and staff are on site, the estimated sewage generated will be 10.5 L/s over a 10 hour period. Using a peaking factor of 1.5 (recommended by MOE Guidelines), and an infiltration rate of 0.2 L/s/ha (prescribed by Region of Peel Guidelines), the resulting current Peak Instantaneous Flow Rate will be 15.8 L/s. This is significantly less than the minimal capacity of the trunk sewer. It is also less than the flow calculated using the Peel and MOE guidelines.

STORMWATER & SITE DRAINAGE

Credit River Flood Plain

The campus is located adjacent to the Credit River. This conveys surface drainage to Lake Ontario. The flood plain for the Credit River was mapped in 1978. Regulations of Credit Valley Conservation (CVC) for the Credit River are based on the Regional Storm (Hurricane Hazel). In addition to the flood plain, the CVC have established regulations that define limits for the placement and removal of fill along the banks of the River. For the Campus, the flood plain is well defined within the valley of the river. The fill restrictions extend onto the tablelands. On the south side of the campus, the restrictions impact the existing parking areas

and touch the edge of the athletic fields. On the east side, the lines include the woodlot located north of the Central Utilities Building.

Site Services

The site grades generally fall from north to south. Areas immediately adjacent to Mississauga Road drain to that road. The remainder of the site's drainage is split between draining to a slight depression represented by the existing pond fronting the Kaneff Centre and the South Academic Buildings and flowing directly to the edge of the Credit River Valley. The study team had virtually no drawings indicating the storm drainage system. There is evidence on the site that storm sewers were constructed with the roads. We also found drawings for residences showing portions of the storm system. Inquiries with the City's Works Department, Plumbing Department and the Credit Valley Conservation only produced information presented on the figure enclosed herein.

Discussion with UTM staff indicated that stormwater drains through the pond at the front of the campus. This acts as a quality pond for the storm drainage from the northern portions of the site. Grades on the Ring Road, south of the Central Utilities Building, south of the South Academic Complex and to the southerly residence indicate that these areas discharge directly to the Credit River. There does not appear to be any quality nor quantity controls associated with these areas.

We have insufficient information to evaluate the sufficiency of the existing storm drainage system. The only complaints raised to date have been associated with problems of high water tables in construction areas on the lower athletic fields. The latter problem is likely due to high ground water in this area that appears to be retained by the soils and topography of the area.

4.1 Regulatory Issues

OFFICIAL PLAN STATUS

The City of Mississauga Official Plan (OP), Erin Mills District Policies of City Plan designates the majority of the UTM campus property as "Major Institutional". A small parcel to the north west facing Mississauga Road is designated Residential 1 - Low Density Residential, having been rezoned several years ago as part of a potential land sale. The University is reconsidering the sale of the land. The portion of the Campus designated Residential 1 - Low Density Residential has a maximum density of 17 units per hectare. Detached, semi detached and duplex dwellings are permitted in this Official Plan/(OP) category.

Under the Major Institutional designation this amendment to the Official Plan anticipates further expansion of the campus and permits the acquisition of adjacent properties for the purposes of expansion. In the OP, Mississauga Road adjacent to the campus is a major collector road that has been identified as a scenic route. Under this scenic route designation, maintenance or physical modification of the road must recognize and preserve its scenic qualities, having regard for the City's Mississauga Road Scenic Route Study. The OP requires that as part of any significant future development, additional and or alternative access points to Mississauga Road should be reviewed.

CURRENT ZONING STATUS

The current zoning on the University of Toronto at Mississauga Campus is R1. This appears to be somewhat at odds with the above noted official plan designation of Major Institutional. However under the present zoning bylaw, Section 19 "Special Uses Exempted From the Provisions of This Bylaw", a public body such as the University can develop without amending the in-force zoning. It can do so providing the proposed development meets the underlying zoning requirements for front, side and rear yard set-backs, lot coverage, landscaped open space and parking requirements. Clearly the proposed development on the campus will meet these standards. In 1990 the University had considered rezoning all lands to a site-specific institutional zoning but ultimately chose not to because of the lengthy public process that was involved.

As it stands today, the University can develop and grow "as-of-right" without any specific restrictions from the City of Mississauga.

CREDIT RIVER CONSERVATION AUTHORITY

The Credit Valley Conservation Authority (CVC) has several mandates that affect the implementation of the Master Plan and its component parts.

The CVC has established flood plain regulations that prohibit development within the area flooded by the River. This should not impact the campus' development unless a new stormwater outfall is required. If required, a permit for its construction would be necessary. Associated with the regulatory flood lines are "cut and fill" control lines. No construction may take place within these areas without the approval of the CVC. Generally the CVC will not permit the construction of new buildings or structures within these lines, as they are concerned about the stability of the valley slopes and the provision of buffers to the flood plain. A further area of concern for the CVC will be the management of stormwater on the site. Through the site plan control process the CVC will generally require the adherence to the policies of the Authority's Water Management Strategy for the Credit River. It would be normal for the CVC to require at least Level 2 Controls and possibly Level 1 Controls. This implies the stormwater will have to be treated on site before it can be discharged to the River. The CVC could also request quantity controls, however, given the location on the river system this may not be required. Initial discussions have been inconclusive as to which direction the CVC would take on this site.

OTHER REGULATORY CONSIDERATIONS

All projects on the UTM campus are subject to Site Plan Control. Requiring the University to apply for and receive Site Plan Approval from the municipality prior to the issuance of a Building Permit for any new construction. Aspects of proposed buildings considered in Site Plan Control processes include building siting and entrances, parking and loading requirements, microclimate and storm water management considerations and the quality and extent of landscaped open space.

TRANSPORTATION LEGEND

| | |
|---|--------------------------------|
|  | Highway and Interchange |
|  | Arterial |
|  | Major Collector |
|  | Major Collector (Scenic Route) |
|  | Minor Collector |
|  | Local Road |

LAND USE LEGEND

| | |
|---|---|
| DC | - District Commercial |
| NC | - Neighbourhood Commercial |
| CC | - Convenience Commercial |
| AC | - Arterial Commercial |
| Com | - Community Centre |
| C | - Community Park |
| N | - Neighbourhood Park |
| CP | - City Park |
| SP | - Special Park |
| P | - Police |
| F | - Firehall |
|  | - Place of Religious Assembly |
|  | - Junior Public School |
|  | - Senior Public School |
|  | - Secondary School |
|  | - Elementary Separate School |
|  | - Secondary Separate School |
|  | - Other Board Facility |
| Univ | - University |
|  | - Existing Stormwater Management Facilities |
|  | - Proposed Stormwater Management Facilities |
|  | - Planning District |

LAND USE DESIGNATIONS

-  Residential – Low Density I
-  Residential – Low Density II
-  Residential – Medium Density I
-  Residential – High Density I
-  Residential – High Density II
-  Retail and Service Commercial
-  Automotive Service Commercial
-  Open Space
-  Greenbelt
-  Major Institutional
-  Parkway Belt West
-  Utility
-  Multiply-Use Centre Boundary

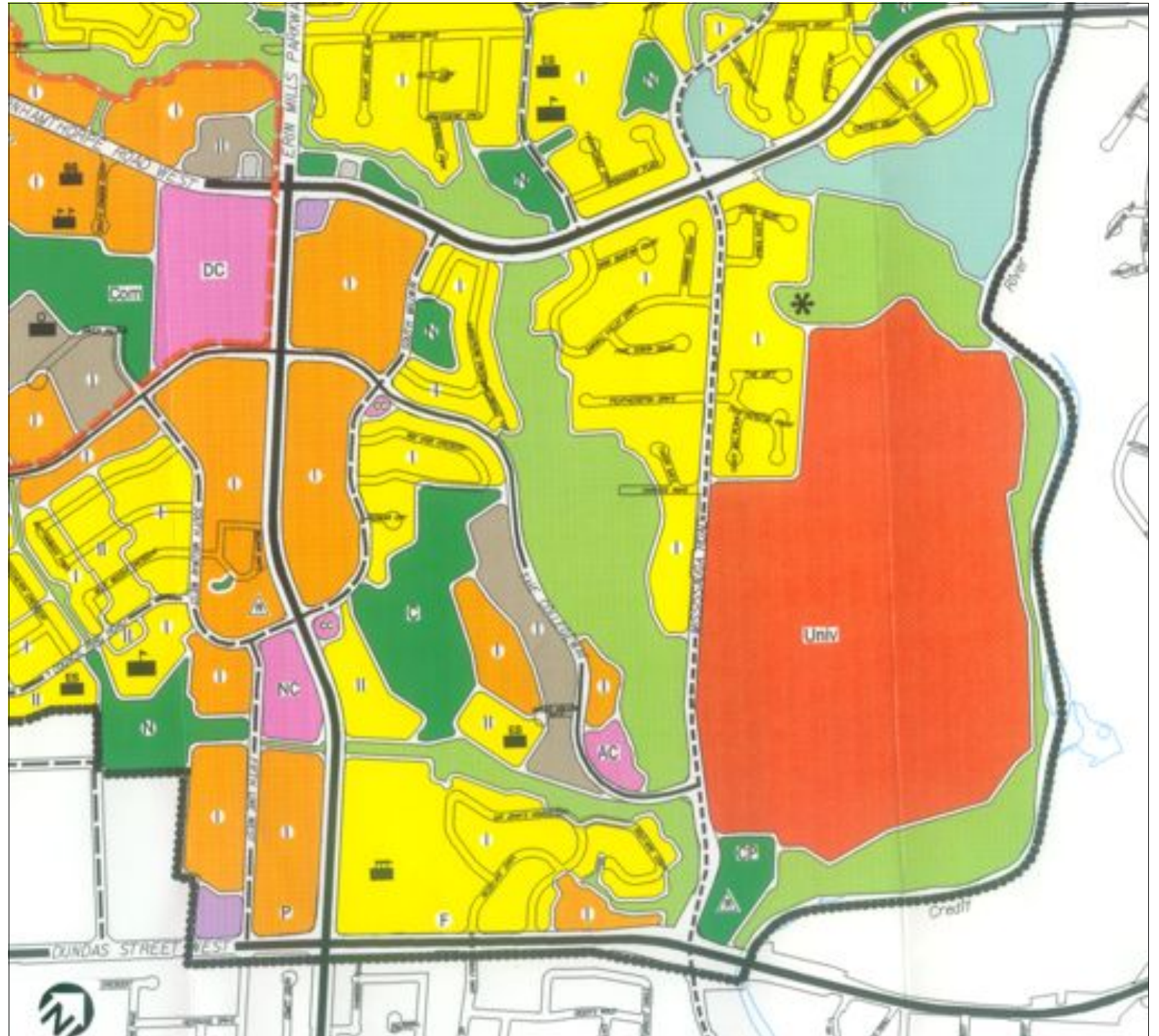



South Building / Five Minute Walk

Five Minute Walk through Woodlot by Old Student Pub towards North Building



5.0 APPENDIX

5.1 Existing Structures

The existing buildings were evaluated in terms of their functionality, program distribution and basic servicing upgrades required. The buildings on the north half of the campus are likely to be replaced with new facilities over time. A coherent phasing plan uses existing buildings efficiently as new facilities are built and as departments and services begin to shift. The individual assessments follow.

SOUTH BUILDING

The South Building has 52,237 gsm and was constructed in 1971 as a first phase of a superstructure that was to accommodate some 25,000 students. At this time it is the true centre of Campus life with the "Meeting Place", Library, Bookstore, Athletic Facilities, Administration Career Counseling, Academic Skills Centre, Health Services, Printing Services, Food Services, etc. The intention over time is to reorganize the program of this building so that it houses administration and other facilities. The Library and the Athletic Facilities would be housed in new buildings while the Student Services, would be relocated strategically and clustered to reinforce the new centre of gravity while improving integration and coordination of services.

The South Building was also examined to investigate possibilities to break up its bulk, create through routes, consolidate departments and knit it into the new fabric of the Campus. There are two "knuckles" illustrated on the plans where more transparent links would tie into the new buildings and courts.

Some areas of the South Building are not adequately serviced. If there are renovations to the South Building, these should incorporate new air handling equipment on the roof in order to free up some capacity for under-serviced areas. Expensive renovations involving heavily serviced facilities are not appropriate for the South Building.

NORTH BUILDING

The North Building, built in 1967, was originally intended as a small administrative headquarters and was expanded in 1969 when construction of the South Buildings was delayed. It continues to serve as a major academic building, housing Humanities disciplines and Anthropology.

The building is in relatively good shape physically, but has several problems that could exclude it from future long-term academic use:

- the internal walls are all concrete block and reconfiguration is costly
- it requires a new HVAC system and updated power and data wiring
- the structure does not appear to offer much flexibility for adaptive reuse for academic activities
- the interior character and overall quality of the building do not reflect the high caliber University academic programs being offered within

On the other hand it has 9459 gsm of space and it could be used for lower maintenance and support facilities for other programs such as the Theatre. It will also be used as a transition / overflow / storage space during the phasing of the Master Plan.

There is an immediate need for additional space in the North Building to house the new Research and Learning Technology Centre. This is an ambitious and exciting plan for that has already received significant equipment and staff funding from the Office of the Provost and will have to be harmonized with those now being formulated around the CCIT proposal. The space is required so that the equipment, already purchased, can be properly installed. The two-year time frame of the CCIT building design and construction period is too far off. This facility is for the use of the division of Humanities as the Humanities users of information technology have different needs from those in other departments and divisions. The daily presence of materials in languages other than English demands special accommodation which only begins with special keyboards and special character recognition. A space of the size of the Student Lounge (Room 165) would suit the need in the short term, but it is recognized that it would be a difficult decision to remove this student amenity.

KANEFF CENTRE

Built in the 1990's, the Kaneff Building houses the Social Sciences facilities. It has a total of 3,344 gsm and includes a large lecture hall which is used by the university programs at large. A small art gallery is also located in the building.

STUDENT CENTRE

Newly opened in late 1999, the Student Centre is 2985 gsm and houses the student offices, pub and meeting rooms. It is a beautiful addition to the Campus but is underutilized for a variety of reasons discussed later on.

COLEMAN HOUSE

This rambling group of wood frame buildings is in poor repair with the exception of the Student lounge at the east end of the building. The lounge was recently built and is used by both resident and commuter students as a study area and informal meeting space. It used to house the Residence Administration offices, but they moved into the new residence when it was opened in 1999. One of the proposed new residence sites requires the demolition a storage component of the Coleman House. Ideally the lounge would be connected with the new residence.

THOMAS COTTAGE

This small wood frame structure is presently a rental property. It is maintained in good repair, but it sits largely as a remnant on the Campus. The cottage is an artifact, out of character with the modern campus. The Master Plan proposes the development of an entry plaza which covers the area where the cottage is located. While it could be retained, ideally it would be relocated or demolished, so that the continuity of the wetland and wood lot is enhanced and the edge between the plaza and the naturalized area is revealed (in the same way that the naturalized areas of the pond and the woodlot are contracted with the adjacent paved areas).

OLD PUB BUILDING

This temporary, light steel frame building was erected in 1970 to meet a desperate need for space and, like most temporary buildings, has survived. It used to be the student pub and, since the new Student Centre was completed, has been used on a temporary basis by the Theatre and Drama Department. It sits in an area where new residences are planned and it will be demolished.

THEATRE BUILDING AND STORAGE HUTS

The theatre building was originally intended as a service building for the College buildings. It was adapted first as science laboratories, then as a small gymnasium and finally as a 75-seat studio theatre, its present use. Smaller "temporary" huts serve as an art studio and storage for the Theatre and Drama Program. The Master Plan site plan indicates that a new residence of 200 rooms can be constructed without demolishing the adjacent theatre building, however, the storage buildings will go.

A proposal for adding to the existing theatre was prepared by the Theatre and Drama Program which would provide two rehearsal halls, set building shop, wardrobe shop and storage, dressing rooms, meeting room and 3 offices. This would ensure the survival of the program as it stands for the next few years, but it does not consider any growth factor.

BUILDINGS ON THE NORTH CAMPUS

As the North Campus is not being used for major new development (except for one new parking lot) in the time frame of this Master Plan, it is recommended that these buildings be maintained as long as they are of use to the UTM.

Lislehurst

The historic home of the Principal, the original estate house is constructed of Credit Valley stone and is representative of the colour palette of materials that future buildings should draw upon to help make the Campus more coherent. Of all the buildings on the North campus, this is the only one that should be preserved in the long term as it adds historic, esthetic and symbolic value to the UTM.

Artist's Cottage

The cottage, located on the north Campus, is currently used for an "artist in residence" program at the UTM. It is wood frame construction and in reasonably good shape.

Geomorphology and the Paleomagnetism Lab

These light steel frame buildings do offer the UTM additional space and one has some sentimental value due to the fact that a Moon rock once resided there, but they are very remotely located and unlikely to be of long-term academic use.



UTM Student Centre



Lower Playing Fields at the UTM



UTM Student Residence Courtyard, Phase 6

ARGOS BUILDINGS

There are currently trailers in the southeast playing fields that house facilities for the Toronto Argonauts. While there are some discussions about the possibility of additional space to be built for the Argos, the UTM has a policy of "no more temporary buildings". It is uncertain whether the Argos will invest in a permanent building on the Campus. The existing trailers will have to be relocated or removed from the site when the UTM Varsity sports facilities are implemented.

RESIDENCES - PHASES 1-6

During the 1970's and the 1980's the UTM built five phases of town house-style residences with approximately 800 beds. Although these are economical, efficient and compatible with the residential neighbourhood developed on the other side of the road and to the north of UTM's North Entrance, they occupy a lot of territory relative to the number of units. Since 1994 the amount of affordable housing within walking distance of the Campus has diminished and the need to provide housing for students is more acute. The newest residence, Phase 6, has 192 beds and offers suite-style accommodation with four bedrooms per suite in four pods connected by corridors to a single, secure access space in the main lobby. The net gain in beds is closer to 100 because some of the Phase 1 town houses were converted to family housing, so the present total number of beds is 909. The proposed Phase 7 residence would enable the UTM to house all first year students and move the UTM closer to the target of 23-5% of the FTE students proposed in the "Raising our Sights" document. However, with the new CCIT building and growth in its Master of Management in Professional Accounting program, an additional 200 beds will be required in the near future.

It seems sensible to maintain the low-rise residential uses on Mississauga Road. However, for future residence projects the more dense, but low-rise, solution for Phase 6 is a more efficient model than the town houses. Universal accessibility issues must be addressed in the construction of new residences to overcome some of the problems identified Phase 6 (only the ground floor units are fully accessible).

5.2 Landscape Assessment

GENERAL APPROACH TO DATE

The University of Toronto Mississauga has presented a challenging mixture of opportunities to landscape development. From its inception the Campus has been striving to work with the uniqueness of the site, its location on the edge of a ravine, and recognized the inherent value in the natural landscape. From its inception, through the inclusion of a pond, wetland and woodlot in its most heavily developed areas the qualities of the location have become a part of the Campus everyday experience.

The built form, particularly the academic portions, and its adjacent spaces, however, have not addressed and encompassed the benefits of their surroundings. Through internalized built form the adjacent outdoor spaces merely act as corridors from one building to another and deny the possibility of an integrated whole. Their forms have done little to alleviate the effects of extreme climactic conditions experienced on the site in winter months. The two most recent developments begin to readdress this by creating buildings that begin to integrate with their surroundings.

The physical integration of the Campus into the community along Mississauga Road has been successful through moderation of the scale of the buildings located along its edge, although the sense of an academic institution and system of pedestrian circulation along this edge requires strengthening. The University's face to the public along Mississauga Road and physical integration with the street lacks presence and a hierarchy of entry to the Campus. This influences the first impression of the University, and affects the message presented by the Campus.

Comprehensive and visionary planning is needed as a framework for the development of the landscape. The conditions and structure exist on the Campus, but the support system requires strengthening.

ECOLOGICALLY SENSITIVE AREAS

The consideration the University has offered, in the inclusion of environmentally sensitive areas in the heart of the Campus, is admirable. These areas serve to connect the heart of the Campus to its surroundings on the Credit River. The ecologically sensitive knoll, wetland, woodlot and pond are vital to the character and sense of place for the Campus and must be strengthened and reinforced as much as possible, while serving to integrate the surrounding Campus as a solid unit. There is a lack of cohesiveness in these areas within the larger context of the Credit River valley. Currently the ecological areas in the heart of the Campus function almost in isolation. Efforts to strengthen these connections should be reinforced.

The connection of the ecological areas to their immediate surroundings is at times tenuous, particularly in the handling of the pond. The road that encircles the pond serves to physically isolate it from the Campus and its depression creates a barrier to all of its edges. This area can be maintained as ecologically sensitive, and feel more integrated into the Campus. Similarly, the extent of the other ecological areas must be assessed to ensure they work at integrating the Campus rather than spatially dividing the Campus. By establishing a balance between the ecological zones and the uses of the University both entities are strengthened.

TRANSITION AREAS

The transition areas occur at the edges of built form and the adjacent Credit River valley. Currently these areas take on a variety of forms from naturalized edges along the Ring Road to grassed areas of playing fields to the edge of the Ring Road. A more seamless integration between the natural zones and the Campus need to be addressed in order to develop a more symbiotic relationship between the two entities.

CREDIT RIVER TRAILS

Currently the system of Credit River trails that extend from the Campus into the river valley have little relationship to the circulation system developed on the Campus. Once again a stronger integration between the two will extend the Campus into the valley, and present the natural environment as an asset to the University. By strengthening this bond the students only serve to benefit and connect more directly to their surroundings.

PLAYING FIELDS

The existing playing fields are placed as undefined elements on the Campus. They are unsupported in their placement and orientation. Working with the playing fields as part of a larger pedestrian system and planting that gives enclosure would anchor the playing fields as elements that are a part of the larger whole of the Campus. The playing fields can be developed as a coherent part of the larger open space system allowing them to function in many ways on the Campus.

CAMPUS OPEN SPACES

One weak aspect of the campus is its open space system in the central area. The open space serves as a simple transition space from one building to another with little or no connection to its surroundings. This is further aggravated by the internalized nature of the existing buildings. The Campus also lacks a major outdoor space that can act as a unifying element to the Campus and the students by providing an area to congregate and connect to their surroundings. The residential areas of the Campus have developed more cohesively through their system of paths and open spaces. The south residential quadrant that is centred on parking lot #5 requires reassessing to reduce the focus and impact of the parking lot.

PATHS AND ROADS

The current entry sequence offers little direction in the hierarchy of the roads. Similarly the road system does not inform users of any hierarchy as they relate to the buildings on the Campus. The road system currently serves a functional purpose, yet it can be developed to set up a system that informs the users. The Ring Road serves as a distinct edge to the heart of the Campus and the ecological zone of the Credit River. There is little integration between the two sides of the road and its sole purpose is functional. The Ring Road could be strengthened and supported as a transition area between the two disparate parts.

Similarly the existing pathways appear to be primarily functional and are not supported by a system of planting, rhythm of trees, places to sit or textures on the walking surfaces. Developing the walkways as a clear part of the new open space system will strengthen their presence and importance on the Campus. A hierarchy in the path system can also serve to inform the students and direct them around the Campus.



Forest Flowers

Rustic Wetland Bridge





Winter - no microclimate mediation



Autumn Maple and Beech Forest

Spring Meadow



PLANTING STRATEGY

The current planting strategy focuses primarily on introduced species with the exception of the ecological zones. An integration of planting strategies between the Campus and the Credit River that promotes a plant diversity, yet strengthens the indigenous plant community is necessary. By strengthening the biodiversity through regeneration and the creation of natural ecologies dynamic and emerging natural systems begin to develop.

The integration of planting strategies in the heart of the Campus will aid in strengthening the presence of the ecological zones as elements that are a part of a larger whole instead of an exception on the Campus. Introduced species, particularly shrubs and ground cover will continue to be necessary in areas directly adjacent to the buildings for a number of reasons: appearance, maintenance requirements, control over size and spreading. Currently, throughout the Campus, there are significant areas that are sodded and require regular maintenance including the playing fields.

SAFETY

Safety and the layout of lighting, paths and walkways appears to be of paramount concern to the University. The current approach will be followed and strengthened wherever possible. Planting strategies will be proposed that reinforce safety on the Campus. Similarly, establishing a hierarchy of walkways and roadways will serve to increase the sense of safety on the Campus by ensuring certain walkways and roads are used more frequently, particularly at night. By developing 'streets' on the Campus safety can be improved.

MICROCLIMATE

Microclimatic conditions have started to be addressed on the Campus. Since the majority of students are studying during the fall and winter months the issue of microclimate must be addressed whenever possible. By moderating the microclimate the impact on users can be significant. By increasing the outdoor use during all seasons safety is increased and a connection to the surroundings is strengthened.

5.3 Recommended next steps

DIGITIZED CAMPUS SURVEY

The development parcels shown in Section 3.10 (New Building Envelopes and Design Principles) show limits of building envelopes that, in some instances, abut very sensitive areas such as the Watershed Area. The base information used to establish these development parcels is somewhat inaccurate. The Watershed area is represented as squiggly lines on the existing digital Campus Site Plan, which was scanned from a hand-drawn survey. It appears to be generally in the right position, but there has been some stretching in the scanning operation that produced the Campus digital site plan. It does not align exactly with the digital information received from the City of Mississauga. In order to clearly delineate where this line is, a full survey should be done that positions this line as a no-build zone. The survey should include a tree survey and site services.

CAMPUS DATA CONSOLIDATION (DIGITAL)

It is important that the UTM consider the creation of a consolidated digital base of information that documents the Campus buildings, site servicing and other survey information mentioned above. This will be required when drawings are produced for the new buildings and when renovations are done in existing buildings. If the UTM does not have this information accurately documented for future consultants, every time a new building is designed or a renovation takes place, the design team will take this into consideration when fees are calculated, and the UTM may end up paying several times for piecemeal digitizing of site information that may or may not be accurate.

ADDITIONAL DETAILED STUDIES REQUIRED

Programming, funding options etc. for the CCIT, Phase 7 Residence and any other buildings coming on line for construction.

MUNICIPAL AND REGIONAL PLANNING PROCESSES

Site Plan Approval for the CCIT and Phase 7 Residence

5.4 Master Plan consultation process / Committee Members

Sterling Finlayson Architects and our Consultant Team would like to thank the following people for their contribution during the Master Plan process. Their insights, enthusiasm and sincere care about the future of the UTM Campus, as well as the time dedicated were very much appreciated by the Master Plan Team.

A Steering Committee was formed with broad representation from the University that included faculty, students and staff from business and support services and administration. The role of the Steering Committee was to:

- Monitor University policy directives that deal with the UTM's long-range goals and philosophies relating to the physical aspects of the academic environment.
- Review information being provided to the Master Plan Team by the sub groups is consistent with the University's policies and mission.
- Answer questions that arise out of meetings with the sub groups and direct the Master Plan team to the appropriate source.
- Resolve contentious issues that arise in the progress of the work.
- Direct staff to provide supporting material to the Steering Committee when required.
- Comment on the direction of the work in progress and provide approvals at key stages.
- Review and comment on draft Master Plan reports.
- Forward final Master Plan Report to the appropriate College Committees for approval.

Three sub Committees were established that represented groups with common interests - Academic Buildings, Non-Academic Buildings and Physical Resource Services The role of these committees was to :

- Provide background information and support to the Steering Committee.
- Review the options proposed by the Steering Committee.
- Review and comment on draft Master Plan reports

The Academic Building Committee was formed to represent the academic departments (Sciences, Social Sciences, Humanities and the Library) that will likely be housed in the new facilities. This group had similar issues to discuss and resolve such as:

- Funding options
- Program development based on projected enrollments
- Future trends in the academic environment
- Location / siting / adjacencies that will result in a better sharing of resources

The Non-Academic Building Committee provided information with regard to a new Athletics Centre, Day Care, Student and Staff Services, Business Services and Residence projects. The issues addressed were similar to the Academic Building Committee, but from a different perspective as these projects are not funded by the government and respond more directly to student services.

The issues around the ecology of the site, transportation, servicing, parking, security, grounds monitoring and resource planning were addressed by the Physical Resource Services Committee. The group addressed the practical, environmental and esthetic considerations from different viewpoints and cost recovery.

The methodology for the production of the Master Plan document included:

- Regular meetings with the Steering Committee which had broad representation across the UTM academic and non-academic departments as well as administration and physical resource services.
- A series of meetings with subgroups to gather information and review findings
- Three workshops to present and develop the work in progress.
- A workshop session with both resident and commuter students
- Meetings with the outside community and Municipal and Conservation Authority representatives
- Web postings documented the process and were made after each workshop. In addition the draft Master Plan Document was posted so that comments could be received.
- Review by the Resource Planning and Priorities Committee, College Council, University of Toronto Governing Council and other University of Toronto bodies.

5.5 Directives from the Steering Committee

- For the purposes of the Master Plan, the Council of Ontario Universities (COU) generated figures were used to plan for growth in three main phases (50 / 75 / 100% growth)
- Detailed programming and spatial configurations was not part of the Master Plan process, but building envelopes have be designated.
- The ecological zones as described in the Master Plan site plan have been maintained.
- No new soil testing was performed, leaving this aspect to the implementation phase of future projects.

Steering Committee Members

- Chair - Gary Sprules - Biology
- Cathy Matthews - Chief Librarian
- Gunter Gad - Geography
- Elizabeth Sisam - University of Toronto Planning Department
- Stephen Johnson - Theatre and Drama Studies Program
- Mark Overton - Registrarial Services
- Preena Chouhan - Student, Administrative Vice President ESCU
- Josh Birtch - Student representative
- Glenn Walker - Chief Administrative Officer (Member, ex-officio)
- Robert McNutt - Principal (Member, ex-officio)

Academic Buildings Group

- Cathy Matthews - Chief Librarian
- Michael Lettieri - Associate Dean, Humanities & P/T Studies
- Robert L. Baker - Associate Dean , Sciences
- Gary Crawford - Associate Dean, Social Sciences
- Preena Chouhan - Student, Administrative Vice President ESCU

Non-Academic Buildings Group

- Lorraine Otoide - Child Care Centre and Family Resources
- Les McCormick - Assistant Principal and Dean of Student Affairs
- Michael Lavelle - Residence Services
- Mary Ann Pilskalnietis - Athletics and Recreation
- Josh Birtch - Student Representative
- Guy Allen - Professional Writing

Physical Resource Services Group

- Nick Collins - Biology
- Christine Capewell - Business Services
- Len Paris - Police Services
- Barb Murck - Ecology
- Sol Kessler - Facility Resource Services

Resident and Commuter Student Group

- Sylvia Baedorff
- Lisa Capobianco
- Preena Chauhan
- Susan Guenther
- Patrick Scantlebury
- Hazlon Schempyer

Other UTM Representatives

- Cecil Houston - Geography
- Diana Borowski - Director - Development, Alumni & Public Affairs

5.6 List of Meeting Reports

LIST OF MEETING REPORTS

- Steering Committee Meeting Reports (6)
- Academic Buildings Group Meeting Reports (2)
- Non-Academic Buildings Group Meeting Reports (2)
- Physical Resource Services Group Meeting Reports (1)
- Municipality Meeting Report (1)
- Community Meeting Report (1)
- Student Meeting Report
- Three Workshop Reports

Workshop 2, May 2000



5.7 List of Reference Documents

Bibliography of reference documents

- City of Mississauga Zoning By-Laws
- UTM Master Plan (1994)
- The Erindale Campus Master Plan 1965
- Map from Ground Users' Committee Report 1990
- Toronto Safer City Guidelines
- COU Building Blocks - Users' Guide
- "Raising our Sights" 2000-2004 - Self Assessment, UTM
- UTM Space Inventory
- Mississauga Road Scenic Route Study (Draft Report)
- Active at UTM
- Proposal to build Phase 7 of Residence - Draft Report
- UTM - Sheridan College Joint Program Initiative in Communication, Culture and Information Technology
- Research and Learning Technology Centre at UTM - A development Proposal, February 1998
- A New Life for the Former Pub - A Proposal by the Theatre and Drama Studies Program
- Rapid Ecological Assessment - Dr. Stephen Murphy
- UTM Committee assessment of the Watershed area.
- Letter from Gayle Dykeman - Chair, Personal Safety Committee
- Letter from David Trott, Chair, Users Committee for the North Building Computing Labs
- Backgrounder - Erindale College Library (17-02-00)

STUDENT / STAFF AMENITIES AND FACILITIES

One of the key features of the Master Plan is to redefine the "centre of gravity" of the Campus so that it becomes integrated with passage through the Campus and is more appropriately located in light of the future development. Student services will be largely moved out of the South Building and will be strategically located to activate and reinforce the major routes on the Campus. Issues to be considered include:

- Food services will operate more effectively and efficiently if they were consolidated and conveniently located close to major routes and large open spaces. The small food operations spread out over the Campus are not efficient.
- The bookstore is owned by an incorporated ancillary of the University of Toronto Press. The current area is adequate, but with the addition of a computer component, it would be too small. Using e-commerce and a better delivery system may mean that more space would not be required. The location should be highly visible and convenient.
- The new recreational facilities will be located in proximity to the new residences and the playing fields. They will be conveniently accessed by car and bus in order to encourage community use.
- Re-programming of the new Student Centre and the development of the Campus around it will be considered. One of the reasons that the new Student Centre was underutilized was that not enough of the student activities moved there - there is no bank, book store, limited food service etc. Centralizing the more entertaining activities would help by shifting the "centre of gravity" of the Campus to a position more accessible to the north and south extremes. It would also make it easier for people to get together.

STUDENT / STAFF AMENITIES AND FACILITIES

One of the key features of the Master Plan is to redefine the "centre of gravity" of the Campus so that it becomes integrated with passage through the Campus and is more appropriately located in light of the future development. Student services will be largely moved out of the South Building and will be strategically located to activate and reinforce the major routes on the Campus. Issues to be considered include:

- Food services will operate more effectively and efficiently if they were consolidated and conveniently located close to major routes and large open spaces. The small food operations spread out over the Campus are not efficient.
- The bookstore is owned by an incorporated ancillary of the University of Toronto Press. The current area is adequate, but with the addition of a computer component, it would

be too small. Using e-commerce and a better delivery system may mean that more space would not be required. The location should be highly visible and convenient.

- The new recreational facilities will be located in proximity to the new residences and the playing fields. They will be conveniently accessed by car and bus in order to encourage community use.
- Re-programming of the new Student Centre and the development of the Campus around it will be considered. One of the reasons that the new Student Centre was underutilized was that not enough of the student activities moved there - there is no bank, book store, limited food service etc. Centralizing the more entertaining activities would help by shifting the "centre of gravity" of the Campus to a position more accessible to the north and south extremes. It would also make it easier for people to get together.